

Dell™ OptiPlex™ FX160/160 Service Manual

[Working on Your Computer](#)

[System Setup](#)

[Selective USB](#)

[Reinstalling Software](#)

[Troubleshooting](#)

[Computer Stand](#)

[Covers](#)

[Hard Drive Assembly \(Optional\)](#)

[NVRAM Module](#)

[Wireless Card](#)

[I/O Board](#)

[Power Supply](#)

[Processor Heatsink Assembly](#)

[Memory](#)

[Coin-Cell Battery](#)

[Cable Guide](#)

[Antenna](#)

[System Board Assembly](#)

[Getting Help](#)

[Finding Information](#)

Notes, Notices, and Cautions

 **NOTE:** A NOTE indicates important information that helps you make better use of your computer.

 **CAUTION:** A CAUTION indicates potential damage to hardware or loss of data if instructions are not followed.

 **WARNING:** A WARNING indicates a potential for property damage, personal injury, or death.

If you purchased a Dell™ n Series computer, any references in this document to Microsoft® Windows® operating systems are not applicable.

Information in this document is subject to change without notice.
© 2008 Dell Inc. All rights reserved.

Reproduction of this material in any manner whatsoever without the written permission of Dell Inc. is strictly forbidden.

Trademarks used in this text: *Dell*, the *DELL* logo, and *OptiPlex* are trademarks of Dell Inc.; *Intel* is registered trademarks of Intel Corporation in the U.S. and other countries; *Microsoft*, *Windows*, *Windows Vista*, the *Windows Start button*, and *Outlook* are registered trademarks of Microsoft Corporation in the United States and/or other countries.

Other trademarks and trade names may be used in this document to refer to either the entities claiming the marks and names or their products. Dell Inc. disclaims any proprietary interest in trademarks and trade names other than its own.

Model DC01T

September 2008 Rev. A00

Antenna

Dell™ OptiPlex™ FX160/160 Service Manual

- [Removing the Antenna](#)
- [Replacing the Antenna](#)

Removing the Antenna

1. Perform the procedure in [Before Working on Your Computer](#).
2. Remove the hard drive bracket assembly, if installed (see [Removing the Hard Drive Bracket Assembly](#)).
3. Remove the WLAN card (see [Removing the Wireless Card](#)).
4. Remove the antenna cable from under the metal tab on the back panel.

⚠ WARNING: Ensure that the antenna wires are in the center of the antenna bushing before pressing the bushing tabs together. If the wires are pushed to the side, they may become damaged when the bushing tabs are pressed.

5. On the inside of the chassis, squeeze the bushings together and at the same time, carefully pull the antenna out the back of the computer.

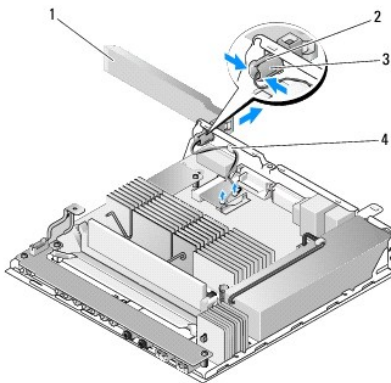

1	wireless antenna	2	antenna holder
3	antenna bushing tabs (2)	4	metal tab over wire mesh

Replacing the Antenna

1. Remove the plug, if installed, from the opening for the antenna in the back panel.
2. If missing, install an antenna holder in the opening for the antenna in the back panel.
3. Route the antenna wires through the antenna holder on the back of the chassis.
4. Align the antenna bushing with the antenna holder of the back panel so that when you flip up the antenna, it will be above the computer (when the computer is in vertical orientation).
5. Push the antenna bushing tabs through the antenna holder until the tabs snap into place.

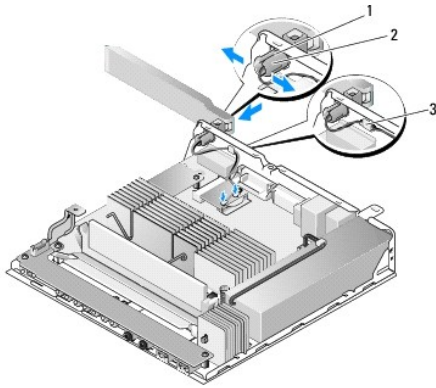

1	antenna holder	2	bushing tabs
3	wire mesh		

6. Replace the WLAN card (see [Replacing the Wireless Card](#)).
7. Route the antenna cable under the tab on the back of the chassis so that the wire mesh surrounding the cable is under the tab.
8. Replace the hard drive bracket assembly if it was removed (see [Replacing the Hard Drive Bracket Assembly](#)).
9. Perform the procedure in [After Working on Your Computer](#).

[Back to Contents Page](#)

[Back to Contents Page](#)

Working on Your Computer

Dell™ OptiPlex™ FX160/160 Service Manual

- [Recommended Tools](#)
- [Before Working on Your Computer](#)
- [After Working on Your Computer](#)

This document provides procedures for removing and installing the components in your computer. Unless otherwise noted, each procedure assumes that:

- 1 You have performed the steps in this section.
- 1 You have read the safety information that shipped with your computer.
- 1 When replacing a component, you have already removed the original, if installed.

 **NOTE:** The color of your computer and certain components may appear differently than shown in this document.







Recommended Tools

The procedures in this document may require the following tools:

- 1 Small flat-blade screwdriver
 - 1 Phillips #1 and Phillips #2 screwdrivers
 - 1 Small plastic scribe
 - 1 Flash BIOS update (see the Dell Support website at support.dell.com)
-

Before Working on Your Computer

Use the following safety guidelines to help protect your computer from potential damage and to help ensure your own personal safety.

-  **WARNING:** Before working inside your computer, read the safety information that shipped with your computer. For additional safety best practices information, see the Regulatory Compliance Homepage at www.dell.com/regulatory_compliance.
-  **WARNING:** Some components become very hot during normal operation. Allow system components to cool before touching them.
-  **CAUTION:** Only a certified service technician should perform repairs on your computer. Damage due to servicing that is not authorized by Dell is not covered by your warranty.
-  **CAUTION:** To avoid electrostatic discharge, ground yourself by using a wrist grounding strap or by periodically touching an unpainted metal surface, such as a connector on the back of the computer.
-  **CAUTION:** When handling your computer, use care not to damage the wireless antenna.
-  **CAUTION:** Handle components and cards with care. Do not touch the components or contacts on a card. Hold a card by its edges or by its metal mounting bracket. Hold a component such as a processor by its edges, not by its pins.
-  **CAUTION:** When disconnecting a cable, pull on the cable's connector or on its strain-relief loop, not on the cable itself. For cable connectors with locking tabs, press inward on the locking tabs to release the connector. When connecting a cable, ensure that the connectors are correctly oriented and aligned to avoid damage to the connector and/or the connector's pins.

1. Ensure that the work surface is flat and clean to prevent the computer surfaces from being scratched.
2. Shut down your computer.

1 In Microsoft® Windows® XP, and Windows XP Embedded: click **Start** → **Shut down** → **Shut down**.

1 In Microsoft Windows Vista®, click **Start** , click the arrow  icon, and then click **Shut Down** to turn off your computer.

 **NOTE:** Ensure that the computer is off and not in a power management mode. If you cannot shut down the computer using the operating system, press and hold the power button for 6 seconds.

3. Disconnect your computer and all attached devices from their electrical outlets.

 **CAUTION:** To disconnect a network cable, first unplug the cable from your computer, and then unplug it from the network wall jack.

4. Disconnect any network cables from the computer.

5. If applicable, remove the computer stand (see [Removing the Computer Stand](#)).

 **WARNING:** To guard against electrical shock, always unplug your computer from the electrical outlet before removing the computer cover.

6. Remove the computer cover (see [Removing the Computer Cover](#)).
-

After Working on Your Computer

After you complete any replacement procedures, ensure you connect any external devices, cards, cables, etc. before turning on your computer.

1. Replace the computer cover (see [Replacing the Computer Cover](#)).
2. Replace the computer stand (see [Replacing the Computer Stand](#)).

 **CAUTION:** To connect a network cable, first plug the cable into the network device and then plug it into the computer

3. Connect a network cable to your computer, if necessary.
 4. Connect your computer and all attached devices to their electrical outlets.
 5. Turn on your computer.
-

[Back to Contents Page](#)

Cable Guide

Dell™ OptiPlex™ FX160/160 Service Manual

- [Removing the Cable Guide](#)
 - [Replacing the Cable Guide](#)
-

Removing the Cable Guide

1. Remove the screw that secures the cable guide to the system board.

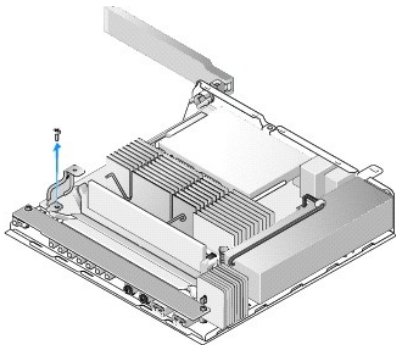

2. Lift the guide out of the computer.
-

Replacing the Cable Guide

1. Align the cable guide screw hole with the hole on the system board.
2. Secure the cable guide to the system board with the screw.

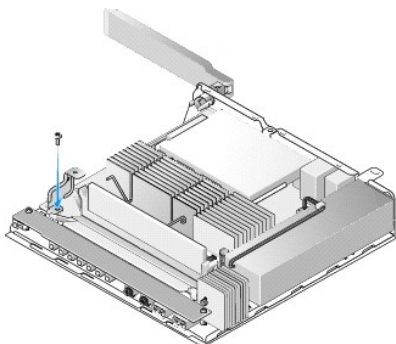

Coin-Cell Battery

Dell™ OptiPlex™ FX160/160 Service Manual

- [Removing the Coin-Cell Battery](#)
- [Replacing the Coin-Cell Battery](#)

One of two types of coin-cell battery sockets is provided with the your computer. One type has retaining clips that wrap along the sides of the battery to hold it in the socket. The other type has a single retaining hook that holds the battery in place.

Removing the Coin-Cell Battery

CAUTION: BIOS setup options revert to the factory default settings when the coin-cell battery is replaced. Before replacing the coin-cell battery, record system BIOS options for future reference. Refer to the [BIOS Setup Utility Options](#).

1. Perform the procedure in [Before Working on Your Computer](#).
2. Depending on the type of battery socket that is provided with your computer, either push the top edge of the battery to out of the retaining clips along the sides of the socket until it can be lifted out, or push back the retaining hook and lift the battery out of the socket.

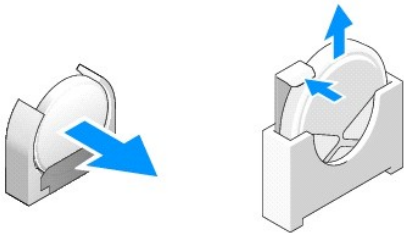

Replacing the Coin-Cell Battery

WARNING: A coin-cell battery can explode if installed incorrectly. Replace the battery only with the type recommended by Dell. Discard used batteries according to the manufacturer's instructions.

1. Slide the battery into the battery socket a slight angle to bypass the retaining clip(s)

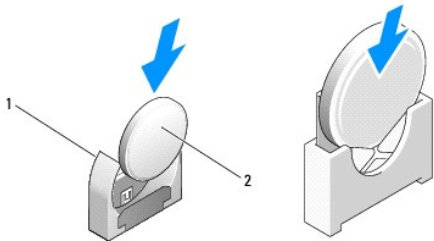

1	coin-cell battery socket	2	coin-cell battery
---	--------------------------	---	-------------------

2. Position the battery upright such that it is seated properly and securely held in place by the retainers.
3. Perform the procedure in [After Working on Your Computer](#).
4. Restart your computer and enter the BIOS setup to configure option settings as needed (see [Entering the BIOS Setup Utility](#)).

Covers

Dell™ OptiPlex™ FX160/160 Service Manual

- [Removing the Computer Cover](#)
 - [Replacing the Computer Cover](#)
 - [Removing the Side Cover](#)
 - [Replacing the Side Cover](#)
-

Removing the Computer Cover

- ⚠ **WARNING:** Always unplug your computer from the electrical outlet before removing the computer cover.
- ⚠ **WARNING:** Some components become very hot during normal operation. Allow system components to cool before touching them.

1. Disconnect the security cable from the computer (if present).
2. Place the computer in a horizontal position.
3. If necessary, move the antenna so that it does not obstruct access to the cover screw.
4. Remove the two screws from the back of the computer.
5. Slide the cover toward the front of the computer and lift it off.

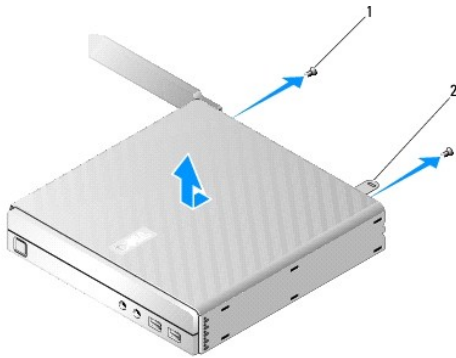

1	screw (2)	2	security cable slot
---	-----------	---	---------------------

Replacing the Computer Cover

1. Place the computer in a horizontal position.
2. Place the computer cover on top of the computer.

The tab with the security cable slot should be toward the back of the computer, and the cover should be approximately 1/4 inch from the system lock tabs being aligned.
3. Slide the cover toward the back of the computer until the system lock tabs are aligned.
4. Replace the two screws that secure the cover to the chassis.

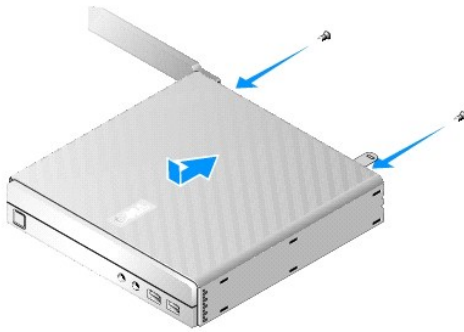

5. Reattach the security cable to your computer, if necessary.

Removing the Side Cover

1. Lift the back edge of the side cover away from the chassis, then slip the hooks under the front edge of the side cover out of the slots on the side of the chassis.

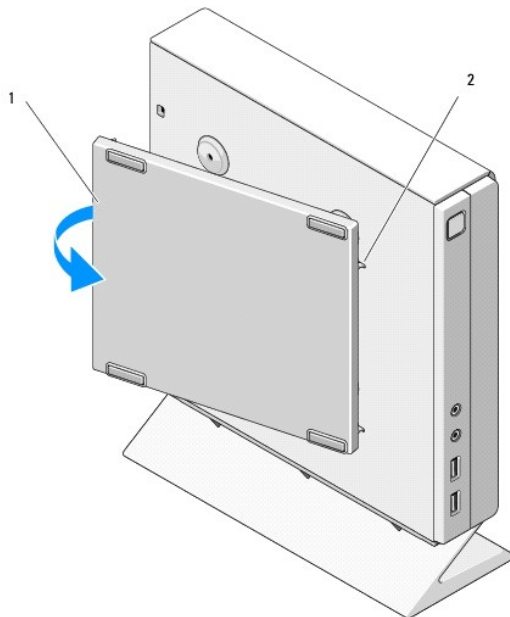

1	side cover	2	side cover hooks slots
---	------------	---	------------------------

Replacing the Side Cover

1. With the side cover at a 30-degree angle to the chassis, slip the hooks under the front edge of the side cover into the slots for the side cover on the left side of the chassis.
2. Swing the back edge of the side cover into the chassis to engage the pegs under the back edge of the cover with the chassis retainers.

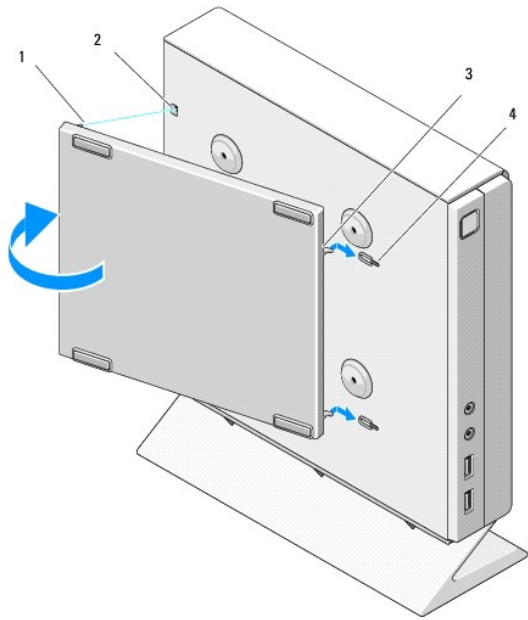



1	peg (2)	2	peg retainer (2)
3	side cover hooks (2)	4	side cover hook slots(2)

[Back to Contents Page](#)

Finding Information

Dell™ OptiPlex™ FX160/160 Service Manual

-  **NOTE:** Some features or media may be optional and may not ship with your computer. Some features or media may not be available in certain countries.
-  **NOTE:** Additional information may ship with your computer.

Document/Media/Label	Contents
Service Tag Express Service Code The Service Tag/Express Service Code is located on your computer and on the BIOS Setup Utility screen.	<ul style="list-style-type: none">1 Use the Service Tag to identify your computer when you use support.dell.com or contact support.1 Enter the Express Service Code to direct your call when contacting support NOTE: Your Service Tag/Express Service Code is located on your computer.
Drivers and Utilities Media The <i>Drivers and Utilities</i> media is a CD or DVD that may have shipped with your computer.	<ul style="list-style-type: none">1 A diagnostic program for your computer1 Drivers for your computer NOTE: Drivers and documentation updates can be found at support.dell.com . <ul style="list-style-type: none">1 Readme files NOTE: Readme files may be included on your media to provide last-minute updates about technical changes to your computer or advanced technical-reference material for technicians or experienced users.
Operating System Media The <i>Operating System</i> media is a CD or DVD that may have shipped with your computer.	<ul style="list-style-type: none">1 Reinstall your operating system
Safety, Regulatory, Warranty, and Support Documentation This type of information may have shipped with your computer. For additional regulatory information, see the Regulatory Compliance Homepage on www.dell.com at the following location: www.dell.com/regulatory_compliance .	<ul style="list-style-type: none">1 Warranty information1 Terms and Conditions (U.S. only)1 Safety instructions1 Regulatory information1 Ergonomics information1 End User License Agreement
Dell™ Technology Guide The <i>Dell Technology Guide</i> is available at support.dell.com .	<ul style="list-style-type: none">1 About your operating system1 Using and maintaining devices1 Understanding technologies such as RAID, Internet, Bluetooth® wireless technology, e-mail, networking, and more.
Microsoft® Windows® License Label Your Microsoft Windows License is located on your computer.	<ul style="list-style-type: none">1 Provides your operating system product key.

Hard Drive Assembly (Optional)

Dell™ OptiPlex™ FX160/160 Service Manual

- [Removing the Hard Drive Bracket Assembly](#)
- [Replacing the Hard Drive Bracket Assembly](#)
- [Removing the Hard Drive](#)
- [Replacing the Hard Drive](#)
- [Removing the Hard Drive Fan](#)
- [Replacing the Hard Drive Fan](#)

Removing the Hard Drive Bracket Assembly

1. Loosen the two captive bracket screws on system board and remove the screw that secures the bracket to the back panel.

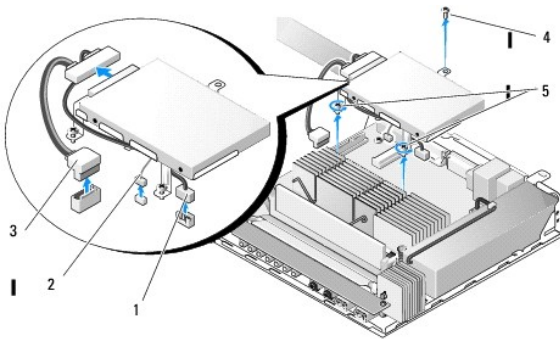

1	SATA hard drive power cable	2	fan cable
3	SATA data cable	4	bracket screw
5	captive screws (2)		

2. Carefully lift up the bracket assembly and disconnect the cables from the system board.
 - a. Disconnect the hard drive SATA data cable from the system board.
 - b. Disconnect the SATA hard drive power cable from the system board.
 - c. Disconnect the hard drive fan cable from the system board.

Replacing the Hard Drive Bracket Assembly

1. Connect the hard drive cables to the system board (see [System Board Connectors](#)).
 - a. Connect the hard drive SATA data cable to the system board.

 **NOTE:** Ensure that the SATA power cable is routed under the hard drive bracket cable retaining clip.

- b. Connect the SATA hard drive power cable to the system board.
 - c. Connect the hard drive fan cable to the system board.

2. Set the bracket assembly in place on the system board, aligning the two captive screws in the bracket feet with the screw holes in the system board, and the hole at the top of the bracket with the screw hole at the top of the chassis back panel.

 **NOTE:** Check cable routing before securing the hard drive bracket to the system board. Ensure that cables are not pinched when the bracket is in place.

3. Tighten the two captive screws that secure the bracket assembly to the system board and replace the screw that secures the bracket to the back panel.

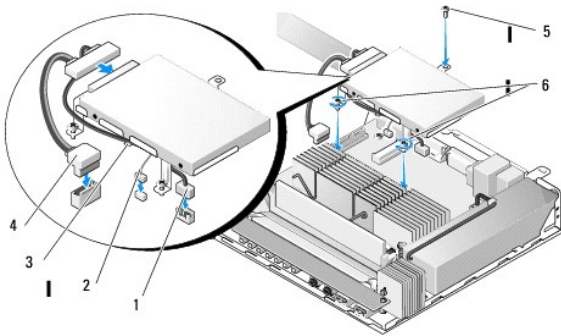

1	SATA hard drive power cable	2	fan cable
3	cable retaining clip	4	SATA data cable
5	bracket screw	6	captive screws (2)

Removing the Hard Drive

1. Perform the procedure in [Before Working on Your Computer](#).
2. Remove the hard drive bracket assembly (see [Removing the Hard Drive Bracket Assembly](#)).
3. Disconnect the SATA data/power cable from the hard drive.
4. Remove the four screws that secure the hard drive to the hard drive bracket assembly.

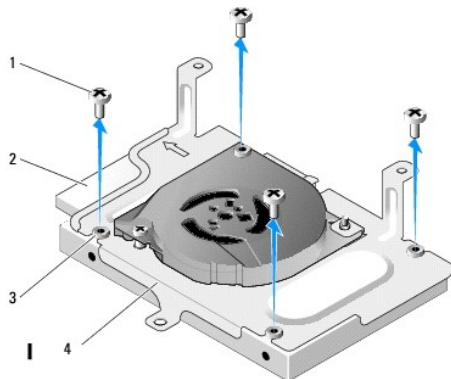

1	screws (4)	2	hard drive connector
3	rubber grommets (4)	4	hard drive bracket assembly

5. Lift the hard drive out of the assembly.

Replacing the Hard Drive

NOTE: Replacement hard drive kits may be shipped with rubber grommets. These grommets must be replaced if any are damaged or missing from the hard drive bracket assembly.

1. Replace all rubber grommets on the hard drive bracket that are damaged or missing.
2. Place the hard drive in the carrier with the label facing up and the cable connectors toward the open end of the bracket.
3. Secure the hard drive to the bracket assembly, affixing the four screws through the rubber grommets.
4. Connect the SATA data/power cable to the hard drive.

 **NOTE:** Ensure that the SATA power cable is routed under the hard drive bracket cable retaining clip.

5. Replace the hard drive bracket assembly (see [Replacing the Hard Drive Bracket Assembly](#)).
 6. Perform the procedure in [After Working on Your Computer](#).
-

Removing the Hard Drive Fan

1. Perform the procedure in [Before Working on Your Computer](#).
1. Remove the hard drive bracket assembly (see [Removing the Hard Drive Bracket Assembly](#)).
2. Remove the hard drive, if installed (see [Removing the Hard Drive](#)).
3. Remove the screw on the bottom of the hard drive bracket assembly.
4. Remove the screw on the top of hard drive bracket assembly.

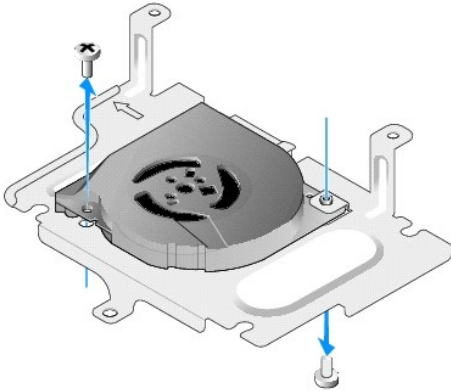

5. Remove the fan from the hard drive bracket.
-

Replacing the Hard Drive Fan

1. Position the fan in the hard drive bracket (see [Removing the Hard Drive Fan](#)).

The screw hole on one corner of the fan should be under the tab on the bottom of the hard drive bracket assembly. The other screw hole should be placed on the post of the hard drive bracket assembly.

2. Secure the fan to the hard drive bracket with two screws, one inserted from below the hard drive bracket, and one inserted from above.
 3. Replace the hard drive if removed (see [Replacing the Hard Drive](#)).
 4. Replace the hard drive bracket assembly (see [Replacing the Hard Drive Bracket Assembly](#)).
 5. Perform the procedure in [After Working on Your Computer](#).
-

[Back to Contents Page](#)

Processor Heatsink Assembly

Dell™ OptiPlex™ FX160/160 Service Manual

- [Removing the Processor Heatsink Assembly](#)
- [Replacing the Processor Heatsink Assembly](#)

Removing the Processor Heatsink Assembly

1. Perform the procedure in [Before Working on Your Computer](#).
2. Remove the hard drive bracket assembly, if installed (see [Removing the Hard Drive Bracket Assembly](#)).
3. Loosen the two captive screws that secure the processor heatsink assembly to the system board.

⚠ WARNING: The heatsink can become very hot during normal operation. Allow the heatsink to cool before touching it.

4. Lift the processor heatsink assembly out of the computer.

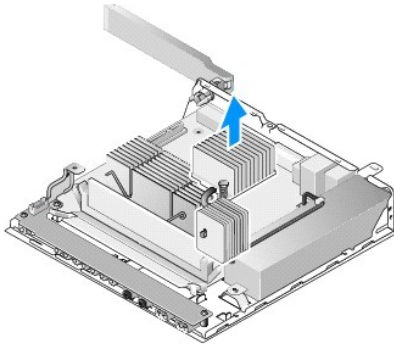

Replacing the Processor Heatsink Assembly

⚠ CAUTION: Apply new thermal grease to the heatsink surface when installing the heatsink assembly onto a different system board. New thermal grease is critical for ensuring adequate thermal bonding, which is necessary for optimal processor performance.

1. If installing the heatsink assembly onto a different system board, clean the thermal interface material or thermal grease from the surface of the heatsink and apply new thermal grease as needed.
2. Align the two captive screws on the processor heatsink assembly with the screw holes on the system board.

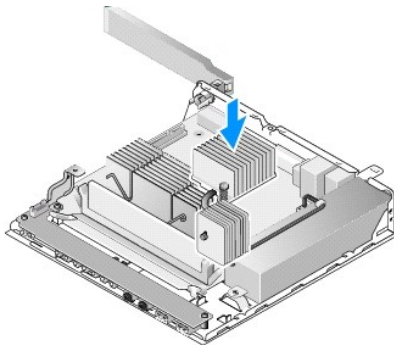

3. Tighten the two captive screws to secure the processor heatsink assembly to the system board.

4. Replace the hard drive bracket assembly if it was removed (see [Replacing the Hard Drive Bracket Assembly](#)).
5. Perform the procedure in [After Working on Your Computer](#).

[Back to Contents Page](#)

[Back to Contents Page](#)

Getting Help

Dell™ OptiPlex™ FX160/160 Service Manual

- [Obtaining Assistance](#)
 - [Problems With Your Order](#)
 - [Product Information](#)
 - [Returning Items for Warranty Repair or Credit](#)
 - [Before You Call](#)
 - [Contacting Dell](#)
-

Obtaining Assistance

 **WARNING:** Before working inside your computer, read the safety information that shipped with your computer. For additional safety best practices information, see the [Regulatory Compliance Homepage](http://www.dell.com/regulatory_compliance) at www.dell.com/regulatory_compliance.

If you experience a problem with your computer, you can complete the following steps to diagnose and troubleshoot the problem:

1. See "[Solving Problems](#)" on [page 43](#) for information and procedures that pertain to the problem your computer is experiencing.
2. See "[Dell Diagnostics](#)" on [page 38](#) for procedures on how to run Dell Diagnostics.
3. Fill out the [Diagnostics Checklist](#).
4. Use Dell's extensive suite of online services available at Dell Support (support.dell.com) for help with installation and troubleshooting procedures. See [Online Services](#) for a more extensive list of Dell Support online.
5. If the preceding steps have not resolved the problem, see [Contacting Dell](#).

 **NOTE:** Call Dell Support from a telephone at or near the affected computer so that the support staff can assist you with any necessary procedures.

 **NOTE:** Dell's Express Service Code system may not be available in all countries.

When prompted by Dell's automated telephone system, enter your Express Service Code to route the call directly to the proper support personnel. If you do not have an Express Service Code, open the **Dell Accessories** folder, double-click the **Express Service Code** icon, and follow the directions.

For instructions on using the Dell Support, see [Technical Support and Customer Service](#).

 **NOTE:** Some of the following services are not always available in all locations outside the continental U.S. Call your local Dell representative for information on availability.

Technical Support and Customer Service

Dell's support service is available to answer your questions about Dell™ hardware. Our support staff uses computer-based diagnostics to provide fast, accurate answers.

To contact Dell's support service, see [Before You Call](#), and then see the contact information for your region or go to support.dell.com.

DellConnect™

DellConnect is a simple online access tool that allows a Dell service and support associate to access your computer through a broadband connection, diagnose your problem and repair it all under your supervision. For more information, go to support.dell.com and click **DellConnect**.

Online Services

You can learn about Dell products and services at the following websites:

www.dell.com

www.dell.com/ap (Asian/Pacific countries only)

www.dell.com/jp (Japan only)

www.euro.dell.com (Europe only)

www.dell.com/la (Latin American and Caribbean countries)

www.dell.ca (Canada only)

You can access Dell Support through the following websites and e-mail addresses:

- 1 Dell Support websites:

support.dell.com

support.jp.dell.com (Japan only)

support.euro.dell.com (Europe only)

- 1 Dell Support e-mail addresses:

mobile_support@us.dell.com

support@us.dell.com

la-techsupport@dell.com (Latin America and Caribbean countries only)

apsupport@dell.com (Asian/Pacific countries only)

- 1 Dell Marketing and Sales e-mail addresses:

apmarketing@dell.com (Asian/Pacific countries only)

sales_canada@dell.com (Canada only)

- 1 Anonymous file transfer protocol (FTP):

[ftp.dell.com](ftp://ftp.dell.com) – log in as user `anonymous`, and use your e-mail address as your password

AutoTech Service

Dell's automated support service—AutoTech—provides recorded answers to the questions most frequently asked by Dell customers about their laptop and desktop computers.

When you call AutoTech, use your touch-tone telephone to select the subjects that correspond to your questions. For the telephone number to call for your region, see [Contacting Dell](#).

Automated Order-Status Service

To check on the status of any Dell products that you have ordered, you can go to support.dell.com, or you can call the automated order-status service. A recording prompts you for the information needed to locate and report on your order. For the telephone number to call for your region, see [Contacting Dell](#).

Problems With Your Order

If you have a problem with your order, such as missing parts, wrong parts, or incorrect billing, contact Dell for customer assistance. Have your invoice or packing slip available when you call. For the telephone number to call for your region, see [Contacting Dell](#).

Product Information

If you need information about additional products available from Dell, or if you would like to place an order, visit the Dell website at www.dell.com. For the telephone number to call for your region or to speak to a sales specialist, see [Contacting Dell](#).

Returning Items for Warranty Repair or Credit

Prepare all items being returned, whether for repair or credit, as follows:

1. Call Dell to obtain a Return Material Authorization Number, and write it clearly and prominently on the outside of the box.

For the telephone number to call for your region, see [Contacting Dell](#). Include a copy of the invoice and a letter describing the reason for the return.

2. Include a copy of the Diagnostics Checklist (see [Diagnostics Checklist](#)), indicating the tests that you have run and any error messages reported by the Dell Diagnostics (see ["Dell Diagnostics" on page 38](#)).
3. Include any accessories that belong with the item(s) being returned (power cables, software floppy disks, guides, and so on) if the return is for credit.
4. Pack the equipment to be returned in the original (or equivalent) packing materials.

You are responsible for paying shipping expenses. You are also responsible for insuring any product returned, and you assume the risk of loss during shipment to Dell. Collect On Delivery (C.O.D.) packages are not accepted.

Returns that are missing any of the preceding requirements will be refused at Dell's receiving dock and returned to you.

Before You Call

 **NOTE:** Have your Express Service Code ready when you call. The code helps Dell's automated-support telephone system direct your call more efficiently. You may also be asked for your Service Tag (located on the back or bottom of your computer).

Remember to fill out the Diagnostics Checklist (see [Diagnostics Checklist](#)). If possible, turn on your computer before you call Dell for assistance and call from a telephone at or near the computer. You may be asked to type some commands at the keyboard, relay detailed information during operations, or try other troubleshooting steps possible only at the computer itself. Ensure that the computer documentation is available.

 **WARNING:** Before working inside your computer, read the safety information that shipped with your computer. For additional safety best practices information, see the [Regulatory Compliance Homepage](http://www.dell.com/regulatory_compliance) at www.dell.com/regulatory_compliance.

Diagnostics Checklist
Name:
Date:
Address:
Phone number:
Service Tag (bar code on the back or bottom of the computer):
Express Service Code:
Return Material Authorization Number (if provided by Dell support technician):
Operating system and version:
Devices:
Expansion cards:
Are you connected to a network? Yes No
Network, version, and network adapter:
Programs and versions:
See your operating system documentation to determine the contents of the system's start-up files. If the computer is connected to a printer, print each file. Otherwise, record the contents of each file before calling Dell.
Error message, beep code, or diagnostic code:
Description of problem and troubleshooting procedures you performed:

Contacting Dell

For customers in the United States, call 800-WWW-DELL (800-999-3355).

 **NOTE:** If you do not have an active Internet connection, you can find contact information on your purchase invoice, packing slip, bill, or Dell product catalog.

Dell provides several online and telephone-based support and service options. Availability varies by country and product, and some services may not be available in your area. To contact Dell for sales, technical support, or customer service issues:

1. Visit support.dell.com, and verify your country or region in the **Choose A Country/Region** drop-down menu at the bottom of the page.
2. Click **Contact Us** on the left side of the page, and select the appropriate service or support link based on your need.
3. Choose the method of contacting Dell that is convenient for you.

[Back to Contents Page](#)

I/O Board

Dell™ OptiPlex™ FX160/160 Service Manual

- [Removing the I/O Board](#)
- [Replacing the I/O Board](#)

Removing the I/O Board

1. Perform the procedure in [Before Working on Your Computer](#).
2. Remove the two screws that secure the I/O board to the chassis.

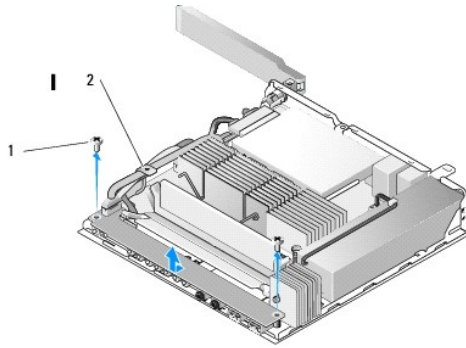

1	screws (2)	2	cable guide
---	------------	---	-------------

3. Carefully lift the I/O board out of the computer, ensuring the three cables are clear of the cable guide.
4. Disconnect the three cables (Audio, USB and Front Panel) from the I/O board.

Replacing the I/O Board

1. Connect the three I/O board cables (Audio, USB, and Front Panel) to the I/O board.

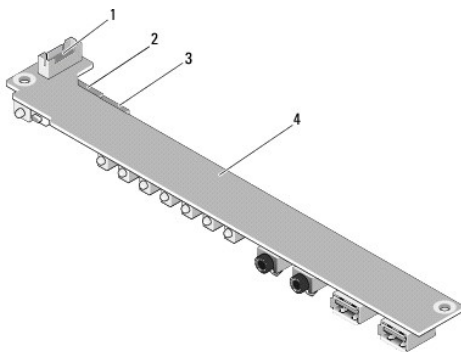

1	front panel connector	2	audio connector
3	USB connector	4	I/O board

2. Place the cables under the cable guide metal tab, and align the holes in the I/O board with the screw holes on the chassis, ensuring that the middle of the I/O board rests in the metal clip.
3. Secure the I/O board to the chassis with two screws.

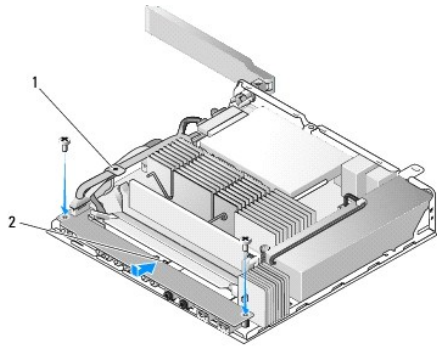

1	cable guide metal tab	2	metal clip
---	-----------------------	---	------------

4. Perform the procedure in [After Working on Your Computer](#).

[Back to Contents Page](#)

Memory

Dell™ OptiPlex™ FX160/160 Service Manual

- [Removing a Memory Module](#)
- [Replacing a Memory Module](#)

Your computer supports one or two memory modules.

NOTE: Your computer supports non-ECC, 667 MHz or 800 MHz, DDR2 SDRAM only. It supports memory module sizes of 512 MB (for embedded Linux operating systems only), 1 GB, and 2 GB. When 800 MHz memory is installed, your computer operates at 667 MHz. See support.dell.com for more information.

Removing a Memory Module

1. Perform the procedure in [Before Working on Your Computer](#).
2. Carefully spread apart the securing clips on each end of the memory module connector until the memory module pops out.

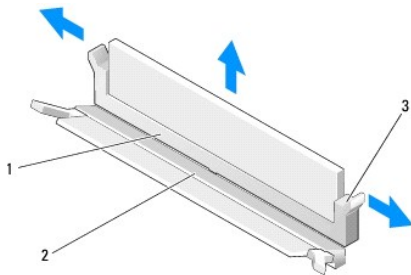

1	DIMM_1 memory connector	2	DIMM_2 memory connector
3	securing clip (two per connector, white – DIMM_1, black – DIMM_2)		

3. Remove the memory module from the connector.

Replacing a Memory Module

NOTE: If your computer contains a single memory module, it must be inserted in the DIMM_1 memory connector. The DIMM_1 connector has white securing clips.

1. Place the module in the memory module connector, and align the notch in the module with the tab on the connector.

NOTE: If the memory module is not installed properly, the computer may not boot. No error message indicates this failure.

2. Press down on the module until the securing clips lock into place. If the clips do not click into place, remove the module and reinstall it.

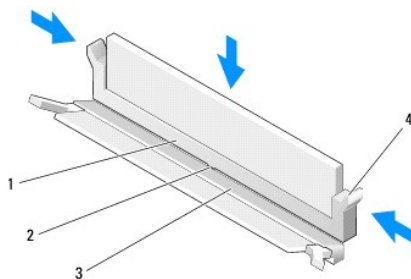

1	DIMM_1 memory	2	tab in memory connector
---	---------------	---	-------------------------

	connector		
3	DIMM_2 memory connector	4	securing clip (two per connector, white - DIMM_1, black - DIMM_2)

3. Perform the procedure in [After Working on Your Computer](#).

[Back to Contents Page](#)

NVRAM Module

Dell™ OptiPlex™ FX160/160 Service Manual

- [Removing the NVRAM Module](#)
- [Replacing the NVRAM Module](#)

Removing the NVRAM Module

1. Perform the procedure in [Before Working on Your Computer](#).
2. Remove the hard drive bracket assembly, if installed (see [Removing the Hard Drive Bracket Assembly](#)).
3. Remove the screw that secures the NVRAM module to the system board with a Phillips #1 screwdriver.

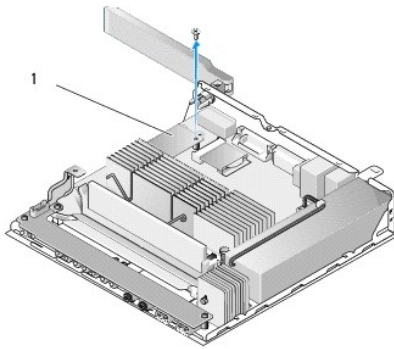

1	NVRAM module		
---	--------------	--	--

4. Lift the NVRAM module straight up from the system board.

Replacing the NVRAM Module

1. Align the NVRAM module connectors with the connectors on the system board and push down (see [System Board Connectors](#)).
2. Secure the NVRAM module to the system board with the screw.
3. Replace the hard drive bracket assembly if it was removed (see [Replacing the Hard Drive Bracket Assembly](#)).

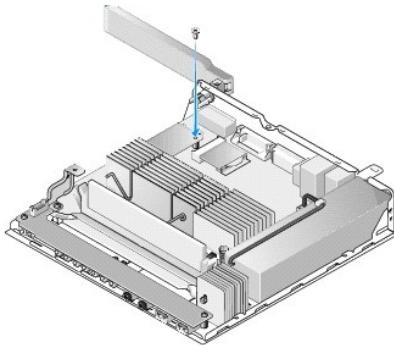

4. Perform the procedure in [After Working on Your Computer](#).
-

[Back to Contents Page](#)

Power Supply

Dell™ OptiPlex™ FX160/160 Service Manual

- [Removing the Power Supply](#)
- [Replacing the Power Supply](#)

Removing the Power Supply

1. Perform the procedure in [Before Working on Your Computer](#).

⚠ WARNING: The power supply can become very hot during normal operation. Allow the power supply to cool before touching it.

2. Disconnect the 12V power supply connector from the system board (see [System Board Connectors](#)).

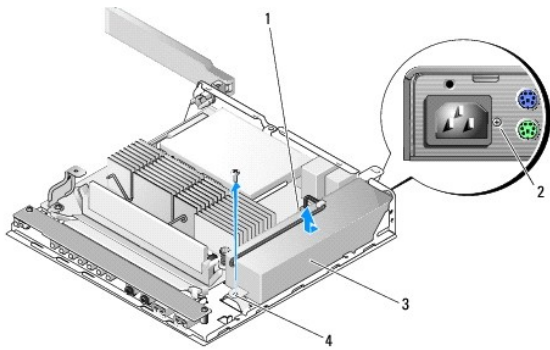

1	power supply 12V connector	2	back panel screw
3	power supply	4	chassis screw

3. Remove the back panel screw.
4. Remove the chassis screw.
5. Slide the power supply slightly toward the front of the computer and lift up out of the chassis.

Replacing the Power Supply

1. Place the power supply in the chassis and slide it back against the back panel.

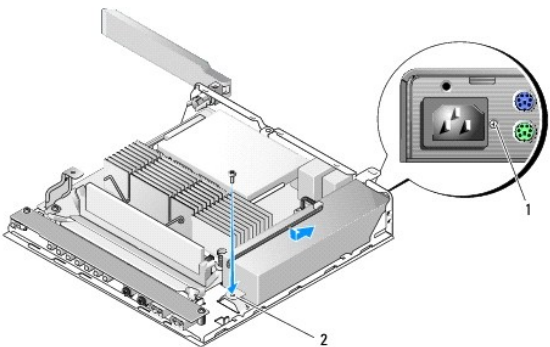

1	back panel screw	2	chassis screw
---	------------------	---	---------------

2. Secure the power supply with a back panel screw and the chassis screw.
 3. Connect the 12V power supply connector to the system board (see [System Board Connectors](#)).
 4. Perform the procedure in [After Working on Your Computer](#).
-

[Back to Contents Page](#)

[Back to Contents Page](#)

Reinstalling Software

Dell™ OptiPlex™ FX160/160 Service Manual

- [Drivers](#)
- [Restoring Your Operating System](#)
- [User Accounts and Passwords](#)

 **CAUTION:** To install or update software on your computer, you must be logged in with administrative privileges. Use extreme care when operating your computer with administrative privileges to prevent damage to the system software.

 **NOTE:** Microsoft® Windows® XP Embedded is available on the OptiPlex FX160 system only.

Drivers

Identifying Drivers

Microsoft® Windows® XP Embedded and Windows XP

1. Locate the list of devices for your computer:
 - a. Click **Start**→ **Control Panel**.
 - b. If the **Control Panel** window appears in Category View (**Pick a category**), switch to Classic View (icon view).
 - c. Double-click **System** icon.
 - d. In the **System** window, click the **Hardware** tab, then click **Device Manager**.
2. Scroll down the list to see if any device has an exclamation point or Other device (a yellow circle with a [!] or ?) on the device icon.

If an exclamation point or question mark is next to the device name, you may need to reinstall the driver or install a new driver (see [Reinstalling Drivers and Utilities](#)).

Microsoft Windows Vista®

1. Locate the list of devices for your computer:
 - a. Click the Windows Vista Start button , and right-click **Computer**.
 - b. Click **Properties**→ **Device Manager**.

 **NOTE:** The **User Account Control** window may appear. If you are an administrator on the computer, click **Continue**; otherwise, contact your administrator to continue.

2. Scroll down the list to see if any device has an exclamation point (a yellow circle with a [!]) on the device icon.

If an exclamation point is next to the device name, you may need to reinstall the driver or install a new driver (see [Reinstalling Drivers and Utilities](#)).

Reinstalling Drivers and Utilities

 **CAUTION:** The Dell Support website at support.dell.com and the Drivers and Utilities media provide approved drivers for your computer. If you install drivers obtained from other sources, your computer might not work correctly.

Returning to a Previous Device Driver Version



Microsoft Windows XP and Windows XP Embedded

1. Locate the list of devices for your computer:
 - a. Click **Start**→ **Control Panel**.

- b. If the **Control Panel** window appears in Category View (**Pick a category**), switch to Classic View (icon view).
 - c. Double-click the **System** icon.
 - d. In the System Properties window, click the **Hardware** tab, and then click **Device Manager**.
2. Right-click the device for which the new driver was installed and click **Properties**.
3. Click the **Drivers** tab→**Roll Back Driver**.

If **Roll Back Driver** does not resolve the problem, use System Restore (see [Restoring Your Operating System](#)) to return your computer to the operating state that existed before you installed the new driver.

Microsoft Windows Vista

1. Click the Windows Vista Start button  , and right-click **Computer**.
 2. Click **Properties**→**Device Manager**.
-  **NOTE:** The **User Account Control** window may appear. If you are an administrator on the computer, click **Continue**; otherwise, contact your administrator to enter the Device Manager.
3. Right-click the device for which the new driver was installed and click **Properties**.
 4. Click the **Drivers** tab→**Roll Back Driver**.



If **Roll Back Driver** does not resolve the problem, use System Restore (see [Restoring Your Operating System](#)) to return your computer to the operating state that existed before you installed the new driver.

Manually Reinstalling Drivers

Microsoft Windows XP and Windows XP Embedded

1. Locate the list of devices for your computer:
 - a. Click **Start**→**Control Panel**.
 - b. If the **Control Panel** window appears in Category View (**Pick a category**), switch to Classic View (icon view).
 - c. Double-click the **System** icon.
 - d. In the System Properties window, click the **Hardware** tab, and then click **Device Manager**.
2. Right-click the device for which you need a driver, and click **Update Driver**.
3. Follow the instructions on the Hardware Update Wizard screens to either install the driver from a local source, or to search the Web for a driver.

Microsoft Windows Vista

1. Click the Windows Vista Start button  , and right-click **Computer**.
 2. Click **Properties**→**Device Manager**.
-  **NOTE:** The **User Account Control** window appears. If you are an administrator on the computer, click **Continue**; otherwise, contact your administrator to continue.
3. Double-click the type of device for which you are installing the driver (for example, **Audio** or **Video**).
 4. Double-click the name of the device for which you are installing the driver.
 5. Click the **Driver** tab→**Update Driver**→**Browse my computer for driver software**.
 6. Click **Browse** and browse to the location to which you previously copied the driver files.
 7. Click the name of the driver→**OK**→**Next**.

8. Click **Finish** and restart your computer.
-

Restoring Your Operating System

Depending on your system configuration, you can restore your operating system in the following ways:

1. For systems with the operating system installed on NVRAM module, the operating system can be re-imaged.
1. Microsoft® Windows System Restore (available only on computers that have hard drives and are running Windows Vista) returns your computer to an earlier operating state without affecting data files. Use System Restore as the first solution for restoring your operating system and preserving data files.
1. If you received the *Operating System* media with your computer, you can use it to restore your operating system. However, using the *Operating System* media deletes all data on the hard drive. This option requires an external optical drive to run the media.

Re-imaging Operating Systems Installed on NVRAM

To restore, update, or install an operating system installed on the NVRAM module, refer to the re-imaging documentation for your computer at support.dell.com.

Restoring Microsoft Windows Operating Systems on Hard Drives

 **NOTE:** The procedures in this document were written for the Windows default view and may not apply if you set your Dell computer to the Windows Classic view.

Starting System Restore

Windows XP

1. Click **Start**→ **All Programs**→ **Accessories**→ **System Tools**→ **System Restore**.
2. Click either **Restore my computer to an earlier time** or **Create a restore point**.
3. Click **Next** and follow the remaining on-screen prompts.

Windows Vista

1. Click the Windows Vista Start button .
2. In the Start Search box, type `System Restore` and press <Enter>.

 **NOTE:** The **User Account Control** window may appear. If you are an administrator on the computer, click **Continue**; otherwise, contact your administrator to continue the desired action.

3. Click **Next** and follow the remaining prompts on the screen.

Undoing the Last System Restore (Windows Vista Only)

 **CAUTION:** Before you undo the last system restore, save and close all open files and exit any open programs. Do not alter, open, or delete any files or programs until the system restoration is complete.

1. Click the Windows Vista Start button .
2. In the **Start Search** box, type `System Restore` and press <Enter>.
3. Click **Undo my last restoration** and click **Next**.

Restoring Your Operating System Using the Operation System Media

Before you Begin

If you are considering reinstalling the Windows operating system to correct a problem with a newly installed driver, first try using Windows Device Driver Rollback. See [Returning to a Previous Device Driver Version](#). If Device Driver Rollback does not resolve the problem, then use Microsoft Windows System Restore to return your operating system to the operating state it was in before you installed the new device driver. See [Restoring Microsoft Windows Operating Systems on Hard Drives](#).

 **CAUTION:** Before performing the installation, back up all data files on your primary hard drive. For conventional hard drive configurations, the primary hard drive is the first drive detected by the computer.

To reinstall Windows, you need the Dell™ *Operation System* media and the Dell *Drivers and Utilities* media.

 **NOTE:** The Dell *Drivers and Utilities* media contains drivers that were installed during the assembly of the computer. Use the Dell *Drivers and Utilities* media to load any required drivers. Depending on the region from which you ordered your computer, or whether you requested the media, the Dell *Drivers and Utilities* media and *Operation System* media may not ship with your computer.

Reinstalling Windows XP or Windows Vista

The reinstallation process can take 1 to 2 hours to complete. After you reinstall the operating system, you must also reinstall the device drivers, virus protection program, and other software.

1. Save and close any open files and exit any open programs.
2. Insert the *Operation System* disc.
3. If the Install Windows message appears, click **Exit**.
4. Restart the computer.

When the DELL logo appears, press <F12> immediately.

 **NOTE:** If you wait too long and the operating system logo appears, continue to wait until you see the Microsoft® Windows® desktop; then, shut down your computer and try again.

 **NOTE:** The next steps change the boot sequence for one time only. On the next start-up, the computer boots according to the devices specified in the system setup program...

5. When the boot device list appears, highlight **CD/DVD/CD-RW Drive** and press <Enter>.

Press any key to **Boot from CD-ROM**, and follow the instructions on the screen to complete the installation.

User Accounts and Passwords

 **CAUTION:** The user account name and password security feature in Windows XP Embedded, Windows XP, and Windows Vista helps you to protect your computer against unauthorized access by those who would extract your personal information or damage the system. Dell strongly advises you to change your operating system user account name and passwords frequently to maintain the effectiveness of this security feature.

Passwords for Windows XP Embedded

If you ordered your computer preloaded with Windows XP Embedded, your computer is configured with user account names and passwords. Refer to support.dell.com for more information.

Changing Account Names and Passwords in Windows

 **NOTE:** To add/remove/change the account name or privileges of a user with Administrative or user level privileges, you must be logged into the operating system as a user with administrative level privileges. If you are logged into the system with user level privileges, you can change only your password.

Windows XP Embedded

1. Click **Start** → **Control Panel**.
2. If the **Control Panel** window appears in Category View (**Pick a category**), switch to Classic View (icon view).

3. Click **Administrative Tools** → **UserManager**.
4. In the left pane, click either **Users** or **Groups**, then double-click the name whose attributes you want to change.

Windows XP

1. Click **Start** → **Control Panel**.
2. If the **Control Panel** window appears in Category View (**Pick a category**), switch to Classic View (icon view).
3. Click **User Accounts**.
4. Click the **User Name** whose password or privileges you want to change, and follow the on-screen instructions.

Windows Vista

1. Click the Windows Vista Start button .
2. Click **Control Panel** → **User Accounts**.
3. Click the item on the screen that you want to change.

[Back to Contents Page](#)

Computer Stand

Dell™ OptiPlex™ FX160/160 Service Manual

- [Removing the Computer Stand](#)
 - [Replacing the Computer Stand](#)
-

Removing the Computer Stand

1. Gently press down on the metal tab at the back of the computer.
2. Slide the stand toward the back of the computer approximately 1/4 of an inch.
3. Remove the stand from the computer.

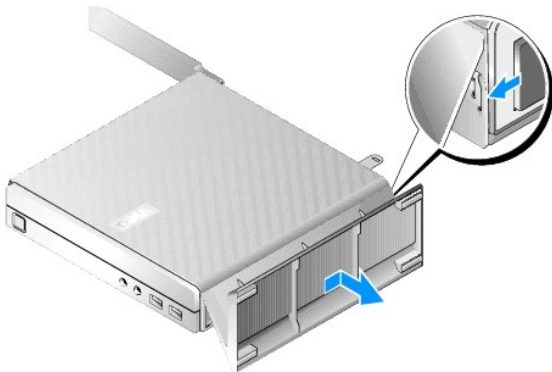

Replacing the Computer Stand

1. Grasp the computer by the top of the chassis.
2. With the part of the stand that has the clip at the back of the computer, align the tabs on the stand with the slots in the bottom of the chassis and insert the tabs into the chassis.

The stand should overlap the back of the computer by approximately 1/4 of an inch.
3. Slide the stand toward the front of the computer until it snaps into place.

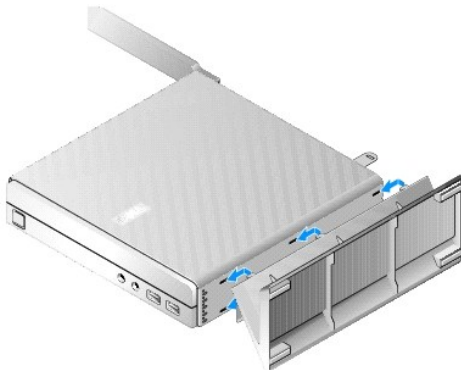

System Board Assembly

Dell™ OptiPlex™ FX160/160 Service Manual

- [System Board Connectors](#)
- [Removing the System Board Assembly](#)
- [Replacing the System Board](#)

System Board Connectors

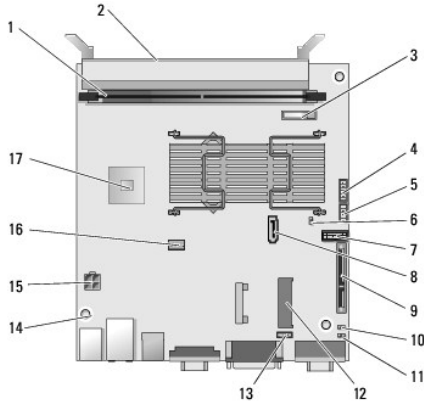

1	memory connector (DIMM_1)	2	memory connector (DIMM_2)
3	battery (BATTERY)	4	audio connector (AUDIOF1)
5	USB connector (USBF1)	6	setup jumper (SETUP_LOCK)
7	front panel connector (FRONTANEL)	8	SATA data cable connector (SATA_1)
9	NVRAM module connector (SATA_0)	10	clear CMOS jumper (RTCST)
11	clear password jumper (PSWD)	12	WLAN connector (MINIA1)
13	fan connector (FAN_CPU)	14	screw holes (3)
15	12V power connector (PWR1)	16	SATA hard-drive power connector (SATAPWR1)
17	CPU		

Removing the System Board Assembly

CAUTION: BIOS options setup in a new system board may not be the same as those setup on the system board you are replacing. To retain the same BIOS option settings, record the current system BIOS option settings for future reference. Refer to [BIOS Setup Utility Options](#) for more information.

1. Perform the procedure in [Before Working on Your Computer](#).
2. Remove the hard drive bracket assembly, if installed ([Removing the Hard Drive Bracket Assembly](#)).
3. Remove the NVRAM module, if installed (see [Removing the NVRAM Module](#)).
4. Remove the wireless card, if installed (see [Removing the Wireless Card](#)).
5. Remove the memory module(s) (see [Removing a Memory Module](#)).
6. Remove the processor heatsink assembly (see [Removing the Processor Heatsink Assembly](#)).
7. Remove the I/O board (see [Removing the I/O Board](#)).

8. Disconnect the I/O board cables from the system board.
9. Disconnect the 12V power supply connector from the system board (see [System Board Connectors](#)).
10. Remove the cable guide (see [Removing the Cable Guide](#)).
11. Remove the two screws on the back corners of the system board that secure it to the chassis.

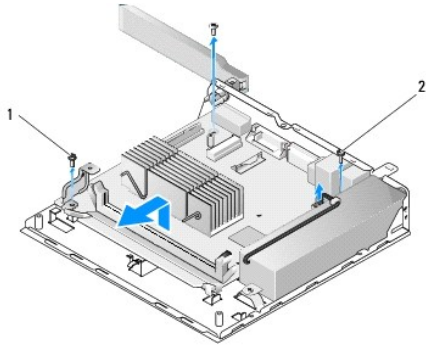

1	cable guide retaining screw	2	system board retaining screw (2)
---	-----------------------------	---	----------------------------------

NOTE: When removing the system board from the chassis, the thermal gap pad between the chassis and the processor may not allow the system board to lift out freely. You may have to break the bond between the gap pad and the bottom of the system board. Keep the gap pad with the chassis.

12. Carefully lift the front edge of the system board remove the board from the chassis.

Replacing the System Board

1. Move the system board into the chassis at about a 30-degree angle, aligning the connectors on the back edge of the board with the cutouts on the back panel, then lower the system board into place.
2. Replace the cable guide (see [Replacing the Cable Guide](#)).
3. Replace the two screws on the back corners of the system board that secure it to the chassis (see [System Board Connectors](#)).

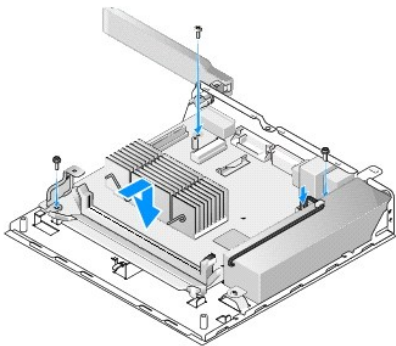

4. Connect the 12V power supply connector to the system board.
5. Replace the I/O board (see [Replacing the I/O Board](#)).
6. Connect the I/O board cables to the system board.
7. Replace the cable guide (see [Replacing the Cable Guide](#)).
8. Replace the memory module(s) (see [Replacing a Memory Module](#)).
9. Replace the wireless card if it was removed (see [Replacing the Wireless Card](#)).

10. Replace the NVRAM module if it was removed (see [Replacing the NVRAM Module](#)).
 11. Replace the processor heatsink assembly (see [Replacing the Processor Heatsink Assembly](#)).
 12. Replace the hard drive bracket assembly if it was removed (see [Replacing the Hard Drive Bracket Assembly](#)).
 13. Perform the procedure in [After Working on Your Computer](#).
 14. Restart your computer and enter the BIOS setup to configure parameter settings as needed (see [Entering the BIOS Setup Utility](#)).
-

[Back to Contents Page](#)

System Setup

Dell™ OptiPlex™ FX160/160 Service Manual

- [Overview](#)
- [Entering the BIOS Setup Utility](#)
- [BIOS Setup Utility Screens](#)
- [BIOS Setup Utility Options](#)
- [Setup Lock](#)
- [Boot Sequence](#)
- [Clearing Forgotten Passwords](#)
- [Clearing CMOS Settings](#)
- [Flashing the BIOS](#)

Overview

Use the BIOS Setup Utility to:

- To change the system configuration information after you add, change, or remove any hardware in your computer
- Enable or disable system board devices
- Enable or disable security features

Before you use the BIOS Setup Utility, it is recommended that you write down the BIOS settings for future reference.

 **CAUTION:** Unless you are an expert computer user, do not change the settings for this program. Certain changes can make your computer work incorrectly.

Entering the BIOS Setup Utility

- Turn on (or restart) your computer.
- When the DELL™ logo is displayed, promptly press <F2> repeatedly until a BIOS screen opens.

 **NOTE:** The Dell logo appears very quickly, so you must watch for it to display. If you press <F2> before you are prompted, the computer cannot acknowledge the keystroke.

- If you wait too long and the initial Dell screen closes, allow the operating system to completely startup. Then, shut down your computer and try again.

BIOS Setup Utility Screens

The BIOS Setup Utility screens display current or changeable configuration information for your computer. Information on the screen is divided into three areas: the options list, active options field, and key functions.

BIOS screen (change screens with left- and right-arrow keys)	
Options List — This field appears on the left side of the BIOS Setup Utility screen. The field is a scrollable list containing parameters that define the configuration of your computer.	Option Field — This field contains information about each option. In this field you can view your current setting, options, and default and make changes to your settings.
Scroll up and down the list with the up- and down-arrow keys. As an option is highlighted, the Option Field displays more information about that option and the option's current and available settings.	Key Functions — This field appears below the Option Field and lists keys and their functions within the active options list.

BIOS Setup Utility Options

 **NOTE:** Depending on your computer and installed devices, the items listed in this section may not appear, or may not appear exactly as listed.

System	
System Time	Allows the user to set the system time and date from within the BIOS.
System Date	
System Info	Lists system information such as the computer name, and other system-specific information. It includes the BIOS version number and the service tag and asset number for support purposes
Processor Info	Identifies whether the computer's processor supports Hyper-Threading and lists the processor type, processor bus speed, processor ID, clock speed, and L2 cache.

Memory Info	Indicates amount of installed memory, memory speed, channel mode, and type of memory installed.
Boot Sequence	Specifies the boot sequence for device types.
Drives	
	Displays the SATA drives in the system (SATA -0, NVRAM: SATA-1, hard disk drive), drive operation and SMART reporting state.
Onboard Devices	
	Displays the enable status of system board components.
Performance	
	Displays the enable status of the hyperthreading feature, CPUID value, and HDD acoustic mode.
Security	
	Displays the enable status of passwords controlling access to BIOS setup and hard disk drive.
Power Management	
AC Recovery	Specifies how the system reacts after a power loss (Off, On, Last (previous state))
Auto Power On	Specifies when to use the Auto Power Time setting (Off, Everyday, Weekdays)
Auto Power Time	Specifies a time to turn the system on.
Low Power Mode	Allows the NIC to be disabled when the system is in hibernate mode or off.
Remote Wake Up	Allows the system to wake from suspend state. This option is dependent on the setting of other options.
Suspend Mode	Selects the power management suspend mode.
Maintenance	
	Displays the service tag, ASF power management, and Event log.
ImageServer	
	Specifies network location for an ImageServer and enables On-demand Desktop Streaming (ODDS) settings.
POST Behavior	
	Specifies options for the Fast Boot, Numlock key, POST hotkeys and keyboard error reporting during startup.

Setup Lock

 **NOTE:** The Setup Lock feature is available on the OptiPlex FX160 system only.

Setup lock (SETUP_LOCK, see [System Board Connectors](#)) is a hardware feature that interacts with the settings of the BIOS Admin Password option, the BIOS Password Changes option, and the hardware Password Jumper (PSWD) to produce a specific behavior of the Setup screens. The most common settings are listed in the table below.

Admin Password	Password Changes setting	Password Jumper Installed	Setup Lock Jumper Installed	Setup Behavior
No	N/A	No	Yes	<ul style="list-style-type: none"> 1 User: view Setup options only 1 Administrator: can modify Setup options 1 Passwords cleared and cannot be set
Yes	Unlocked	Yes	N/A	<ul style="list-style-type: none"> 1 User: can view, and can only set/change the System and HDD passwords 1 Administrator: can modify options after entering proper password
Yes	Locked	Yes	N/A	<ul style="list-style-type: none"> 1 User: view Setup options only 1 Administrator: can modify options after entering proper password

Boot Sequence

Your computer can boot from any of the following device types:

- 1 **Removable Drives** — The computer attempts to boot from an external device such as a floppy drive.
- 1 **Hard Disk Drive** — The computer attempts to boot from an internal drive such as the NVRAM module (SATA-0 port) or hard disk drive (SATA-1 port).
- 1 **CD/DVD Drive** — The computer attempts to boot from the CD or DVD drive. CD and DVD drives are external devices.
- 1 **USB Drive** — The computer attempts to boot from a bootable USB drive. Insert the memory device into a USB port and restart the computer.
- 1 **Network Drive** — The computer may receive its operating system from a network drive, such as an ImageServer.

Changing Boot Sequence for Future Boots

When establishing the boot sequence, first establish the boot order of devices within device type groups, then select the boot order of device types.

1. Enter the BIOS Setup Utility (see [Entering the BIOS Setup Utility](#)).
2. Use the left- and right-arrow keys to navigate to the **System** screen.
3. Use the down-arrow key to highlight **Boot Sequence**, and press <Enter> to open the sub screen.

 **NOTE:** Write down your current boot sequence in case you want to restore it.

4. Set up the boot priority of devices in device types:
 - a. Use the down- and up-arrow keys to highlight **Removable Drives** and press <Enter>. If a drive is not installed, press <Esc> to return to the **Boot Sequence** sub screen.
 - b. On the **Removable Drives** screen, use the up- and down- arrow keys to highlight **1st Drive**, and then press <Enter>.
 - c. In the **Options** pop-up window, use the up- and down-arrow keys to highlight the preferred first removable device, or select **Off** to disable it, and then press <Enter>. Repeat this sub-step for the **2nd, 3rd, etc. Drives**, if listed. Press <Esc> to return to the **Boot Sequence** sub screen.
 - d. Repeat this step for each of the remaining device types: **Hard Disk Drives, USB Drives, CD/DVD Drives, and Network Drives**.
5. Set up the boot priority of device types:
 - a. On the **Boot Sequence** sub screen, use the up- and down-arrow keys to highlight **1st Boot Device**, and press <Enter> to open the **Options** pop-up window.
 - b. In the **Options** pop-up window, use the up- and down-arrow keys to highlight the preferred 1st Boot Device type, and press <Enter>. The 1st Boot Device is the primary device type to boot from.
 - c. Repeat this step for the **2nd, 3rd, 4th, and 5th Boot Devices** to establish the boot sequence order of device types the computer will attempt to boot from.
6. Press <F10> and then press <Enter> to save your settings and reboot your system.

Select Specific Boot Device

During system startup, you can select any bootable device, such as an internal or external hard drive, an external CD or DVD drive, USB memory key, or external floppy drive, without changing the boot device sequence in the BIOS. This feature is useful when booting to an external DVD drive to run Dell Diagnostics from the *Dell Drivers and Utilities* media, and returning to your normal boot sequence during the next system startup.

1. Turn on (or restart) your computer.
2. When the Dell logo appears, promptly press <F12> repeatedly until the **Boot Device Menu** appears.

If you wait too long and the operating system logo appears, continue to load the system until you see the operating system desktop. Then shut down your computer and try again.
3. Use the up- and down-arrow keys to select the device you want to boot to, and then press <Enter>.

Clearing Forgotten Passwords

 **WARNING:** Before working inside your computer, read the safety information that shipped with your computer. For additional safety best practices information, see the [Regulatory Compliance Homepage at www.dell.com/regulatory_compliance](http://www.dell.com/regulatory_compliance).

 **CAUTION:** This process erases both the system and administrator passwords.

1. Perform the procedure in [Before Working on Your Computer](#).
2. Remove the jumper from the password jumper (PSWD) pins on the system board (see [System Board Connectors](#)).
3. Perform the procedure in [After Working on Your Computer](#).
4. Restart your computer and allow it to boot to the operating system desktop.
5. Shut down your computer.
6. Perform the procedure in [Before Working on Your Computer](#).

7. Replace the jumper on the password jumper (PSWD) pins.
8. Perform the procedure in [After Working on Your Computer](#).

 **NOTE:** This procedure enables the password feature. When you enter the BIOS Setup Utility, both system and administrator password options appear as Not Set—meaning that the password feature is enabled but no password is assigned.

9. Restart your computer and enter **Setup** (see [Entering the BIOS Setup Utility](#)).
 10. Assign new system and/or administrator password(s).
-

Clearing CMOS Settings

 **WARNING:** Before working inside your computer, read the safety information that shipped with your computer. For additional safety best practices information, see the [Regulatory Compliance Homepage at www.dell.com/regulatory_compliance](http://www.dell.com/regulatory_compliance).

1. Perform the procedure in [Before Working on Your Computer](#).

 **NOTE:** The computer must be disconnected from the electrical outlet to clear the CMOS setting.

2. Reset the current CMOS settings:
 - a. Locate the clear CMOS jumper (RTCRST) pins and the password jumper (PSWD) pins on the system board (see [System Board Connectors](#)).
 - b. Remove the jumper from the password jumper (PSWD) pins and place it on the clear CMOS jumper (RTC_RST) pins.
 - c. Wait 30 seconds.
 - d. Remove the jumper from the clear CMOS jumper (RTC_RST) pins and place it onto the password jumper (PSWD) pins.
 3. Perform the procedure in [After Working on Your Computer](#).
 4. Reboot your computer.
 5. Your computer will emit beeps, and then issue a CMOS checksum error. Press <F1> to continue.
-

Flashing the BIOS

 **CAUTION:** When installing BIOS software, use only the BIOS software indicated for your computer.

The BIOS Setup Utility resides within the BIOS on the system board. If you install a new system board, you may need to update (or *flash*) the BIOS.

1. Turn on the computer.
2. Locate the latest BIOS update file for your computer at support.dell.com.
3. Click **Download Now** to download the file.
4. If the **Export Compliance Disclaimer** window appears, click **Yes, I Accept this Agreement**.
The **File Download** window appears.
5. Click **Save this program to disk**, and then click **OK**.
The **Save In** window appears.
6. Click the down arrow to view the **Save In** menu, select **Desktop**, and then click **Save**.
The file downloads to your desktop.
7. Click **Close** if the **Download Complete** window appears.
The file icon appears on your desktop and is titled the same as the downloaded BIOS update file.
8. Double-click the file icon on the desktop and follow the instructions on the screen.

[Back to Contents Page](#)

[Back to Contents Page](#)

Dell™ OptiPlex™ FX160/160 Service Manual

 **NOTE:** A NOTE indicates important information that helps you make better use of your computer.

 **CAUTION:** A CAUTION indicates potential damage to hardware or loss of data if instructions are not followed.

 **WARNING:** A WARNING indicates a potential for property damage, personal injury, or death.

If you purchased a Dell™ n Series computer, any references in this document to Microsoft® Windows® operating systems are not applicable.

Information in this document is subject to change without notice.

© 2008 Dell Inc. All rights reserved.

Reproduction of this material in any manner whatsoever without the written permission of Dell Inc. is strictly forbidden.

Trademarks used in this text: *Dell*, the *DELL* logo, and *OptiPlex* are trademarks of Dell Inc.; *Intel* is registered trademarks of Intel Corporation in the U.S. and other countries; *Microsoft*, *Windows*, *Windows Vista*, the *Windows Start button*, and *Outlook* are registered trademarks of Microsoft Corporation in the United States and/or other countries.

Other trademarks and trade names may be used in this document to refer to either the entities claiming the marks and names or their products. Dell Inc. disclaims any proprietary interest in trademarks and trade names other than its own.

September 2008 Rev. A00

[Back to Contents Page](#)

Troubleshooting

Dell™ OptiPlex™ FX160/160 Service Manual

- [Tools](#)
- [Dell Diagnostics](#)
- [Solving Problems](#)
- [Dell Technical Update Service](#)

 **WARNING:** Before working inside your computer, read the safety information that shipped with your computer. For additional safety best practices information, see the Regulatory Compliance Homepage at www.dell.com/regulatory_compliance.

 **WARNING:** Always unplug your computer from the electrical outlet before opening the computer cover.

Tools

Power Lights

The power button light located on the front of the computer illuminates and blinks or remains solid to indicate different states:

- 1 If the power light is blue and the computer is not responding, see [Diagnostic Lights](#).
- 1 If the power light is blinking blue, the computer is in standby mode. Press a key on the keyboard, move the mouse, or press the power button to resume normal operation.
- 1 If the power light is off, the computer is either turned off or is not receiving power.
 - o Reseat the power cable into both the power connector on the back of the computer and the electrical outlet.
 - o If the computer is plugged into a power strip, ensure that the power strip is plugged into an electrical outlet and that the power strip is turned on.
 - o Bypass power protection devices, power strips, and power extension cables to verify that the computer turns on properly.
 - o Ensure that the electrical outlet is working by testing it with another device, such as a lamp.
 - o Ensure that the 12V power cable and front panel cable are securely connected to the system board (see [System Board Connectors](#)).
- 1 If the power light is steady amber, a device may be malfunctioning or incorrectly installed.
 - o Remove and then reinstall the memory modules (see [Memory](#)).
 - o Remove and then reinstall the NVRAM module, if installed (see [NVRAM Module](#)).
 - o Remove and then reinstall the wireless card, if installed (see [Wireless Card](#)).
- 1 Eliminate interference. Some possible causes of interference are:
 - o Power, keyboard, and mouse extension cables
 - o Too many devices on a power strip
 - o Multiple power strips connected to the same electrical outlet





Diagnostic Lights

 **WARNING:** Before working inside your computer, read the safety information that shipped with your computer. For additional safety best practices information, see the Regulatory Compliance Homepage at www.dell.com/regulatory_compliance.

To help troubleshoot a problem, your computer has four diagnostic lights labeled 1, 2, 3, and 4 on the front panel. When the computer starts normally, the lights flash, and then turn off. If the computer malfunctions, use the sequence of the lights to help identify the problem.

 **NOTE:** After the computer completes POST, all four lights turn off before booting to the operating system.

Diagnostic Light Codes During POST

Light Pattern	Problem Description	Suggested Resolution
   	The computer is in a normal <i>off</i> condition or a possible pre-BIOS failure has occurred.	<ol style="list-style-type: none">1 Plug the computer into a working electrical outlet and press the power button (see Power Problems).1 If the problem persists, contact Dell (see Contacting Dell).

①②③④	A possible BIOS failure has occurred; the computer is in the recovery mode.	<ul style="list-style-type: none"> 1 Clear CMOS (see Clearing CMOS Settings) 1 Re-flash the BIOS or install a BIOS update (see Flashing the BIOS) and restart the computer. 1 If the problem persists, contact Dell (see Contacting Dell).
①②③④	A possible processor failure has occurred.	<ul style="list-style-type: none"> 1 Contact Dell (see Contacting Dell).
①②③④	Memory modules are detected, but a memory failure has occurred.	<ul style="list-style-type: none"> 1 If two memory modules are installed, remove the modules (see Removing a Memory Module), then reinstall one module (see Replacing a Memory Module) and restart the computer. If the computer starts normally, continue to install additional memory modules (one at a time) until you have identified a faulty module or reinstalled all modules without error. 1 If available, install working memory of the same type into your computer (see Memory). 1 If the problem persists, contact Dell (see Contacting Dell).
①②③④	A possible PCI device failure has occurred.	<ul style="list-style-type: none"> 1 If a wireless card is installed, remove the card (see Removing the Wireless Card) and restart your computer. If the problem disappears, install a new wireless card. 1 If the problem persists, contact Dell (see Contacting Dell).
①②③④	A possible graphics failure has occurred.	<ul style="list-style-type: none"> 1 Contact Dell (see Contacting Dell).
①②③④	A possible storage device failure has occurred.	<ul style="list-style-type: none"> 1 If a hard drive is installed, reseat the drive's power and data cable connectors (see Removing the Hard Drive Bracket Assembly) and restart your computer. 1 If a NVRAM module is installed, reseat the module (see NVRAM Module) and restart your computer. 1 If the problem persists, contact Dell (see Contacting Dell).
①②③④	A possible USB failure has occurred.	<ul style="list-style-type: none"> 1 Reinstall all USB devices, check cable connections, and then restart the computer. 1 If the problem persists, contact Dell (see Contacting Dell).
①②③④	No memory modules are detected.	<ul style="list-style-type: none"> 1 If two memory modules are installed, remove the modules (see Removing a Memory Module), then reinstall one module (see Replacing a Memory Module) and restart the computer. If the computer starts normally, continue to install additional memory modules (one at a time) until you have identified a faulty module or reinstalled all modules without error. 1 If available, install working memory of the same type into your computer (see Memory). 1 If the problem persists, contact Dell (see Contacting Dell).
①②③④	System board failure has occurred.	<ul style="list-style-type: none"> 1 Contact Dell (see Contacting Dell).
①②③④	Memory modules are detected, but a memory configuration or compatibility error exists.	<ul style="list-style-type: none"> 1 Ensure that no special requirements for memory module/connector placement exist (see Memory). 1 Ensure that the memory you are using is supported by your computer (see Memory). 1 If the problem persists, contact Dell (see Contacting Dell).
①②③④	A possible system board resource and/or hardware failure has occurred.	<ul style="list-style-type: none"> 1 Contact Dell (see Contacting Dell).
①②③④	Another failure has occurred.	<ul style="list-style-type: none"> 1 If a hard drive is installed, reseat the drive's power and data cable connectors (see Hard Drive Assembly (Optional)) and restart your computer. 1 If a NVRAM module is installed, reseat the module (see NVRAM Module) and restart your computer. 1 If there is an error message on the screen identifying a problem with a device (such as the hard drive), check the device to make sure it is functioning properly. 1 If the operating system is attempting to boot from a device (such as a CD/DVD drive), check BIOS settings to ensure the boot sequence is correct for the devices installed on your computer. 1 If the problem persists, contact Dell (see Contacting Dell).

Beep Codes

Your computer may emit a series of beeps during start-up if the monitor cannot display errors or problems. For example, one possible beep code may consist of three short, repeated beeps indicating that the computer has encountered a possible system board failure.

If your computer emits a series of beeps during start-up:

1. Write down the beep code.
2. Run the Dell Diagnostics to further identify the problem. (see [Dell Diagnostics](#)).

Code (repetitive short beeps)	Description	Suggested Resolution
1	BIOS checksum failure. Possible system board failure.	<ul style="list-style-type: none"> 1 Contact Dell (see Contacting Dell).
2	No memory modules are detected.	<ul style="list-style-type: none"> 1 If two memory modules are installed, remove the modules (see Removing a Memory Module), then reinstall one module (see Replacing a Memory Module) and restart the computer. If the computer starts

		<p>normally, continue to install additional memory modules (one at a time) until you have identified a faulty module or reinstalled all modules without error.</p> <ul style="list-style-type: none"> 1 If available, install working memory of the same type into your computer (see Memory). 1 If the problem persists, contact Dell (see Contacting Dell).
3	<p>Possible system board failure.</p> <p>Time-Of-Day Clock test failure</p> <p>Keyboard controller test failure</p>	<ul style="list-style-type: none"> 1 If the problem persists, contact Dell (see Contacting Dell).
4	RAM Read/Write failure.	<ul style="list-style-type: none"> 1 Ensure that no special requirements for memory module/connector placement exist (see Memory). 1 Ensure that the memory you are using is supported by your computer (see Memory). 1 If the problem persists, contact Dell (see Contacting Dell).
5	Real time clock failure. Possible battery or system board failure.	<ul style="list-style-type: none"> 1 Replace the battery (see Replacing the Coin-Cell Battery). 1 If the problem persists, contact Dell (see Contacting Dell).
6	Video BIOS Test Failure.	<ul style="list-style-type: none"> 1 Contact Dell (see Contacting Dell).
7	CPU Cache test failure	<ul style="list-style-type: none"> 1 Contact Dell (see Contacting Dell).

System Messages

 **NOTE:** If the message you received is not included below, see the documentation for either the operating system or the program that was running when the message appeared.

Alert! Previous attempts at booting this system have failed at checkpoint [nnnn]. For help in resolving this problem, please note this checkpoint and contact Dell Technical Support — The computer failed to complete the boot routine three consecutive times for the same error (see [Contacting Dell](#) for assistance).

CMOS checksum error — Possible motherboard failure or RTC battery low. Replace the battery (see [Coin-Cell Battery](#) or see [Contacting Dell](#) for assistance).

CPU fan failure — Replace the CPU fan (see [Removing the Hard Drive Fan](#)).

Diskette Drive 0 seek failure — A cable may be loose, or the computer configuration information may not match the hardware configuration. Check HDD cable connections, if installed ([Removing the Hard Drive Bracket Assembly](#)) and reseal the NVRAM module, if installed (see [Removing the NVRAM Module](#)).

Diskette read failure — The floppy disk may be defective or a cable may be loose. Check the cable connections to the floppy disk device.

Hard-disk read failure — Possible HDD failure during HDD boot test (see [Contacting Dell](#) for assistance). Check HDD cable connections, if installed ([Removing the Hard Drive Bracket Assembly](#)) and reseal the NVRAM module, if installed (see [Removing the NVRAM Module](#)).

Keyboard failure — Keyboard failure or keyboard cable loose (see [Keyboard Problems](#)).

No boot device available — The system cannot detect a bootable device or partition.

- 1 If the NVRAM module is your boot device, ensure that it is properly seated (see [NVRAM Module](#)).
- 1 If the floppy drive is your boot device, ensure that the cables are connected and that a bootable floppy disk is in the drive.
- 1 If the hard drive is your boot device, ensure that the cables are connected and that the drive is installed properly and partitioned as a boot device (see [Hard Drive Assembly \(Optional\)](#)).
- 1 Enter the BIOS Setup Utility and ensure that the boot sequence information is correct (see [Entering the BIOS Setup Utility](#)).

No timer tick interrupt — A chip on the system board might be malfunctioning or motherboard failure (see [Contacting Dell](#) for assistance).

Non-system disk or disk error — Replace the floppy disk with one that has a bootable operating system or remove the floppy disk and restart the computer.

Not a boot diskette — Insert a bootable floppy disk and restart your computer.

NOTICE – Hard Drive SELF MONITORING SYSTEM has reported that a parameter has exceeded its normal operating range. Dell recommends that you back up your data regularly. A parameter out of range may or may not indicate a potential hard drive problem. — S.M.A.R.T error, possible HDD failure. This feature can be enabled or disabled in BIOS setup.

USB over current error — There are issues with a USB device that is connected to the computer. Refer to troubleshooting documentation for the device.

Hardware Troubleshooter

If a device is either not detected during the operating the BIOS Setup Utility or is detected but incorrectly configured, you can use the Hardware Troubleshooter to resolve the incompatibility.

Microsoft Windows XP Embedded:

A hardware troubleshooting utility is not included within Windows XP Embedded. It is provided through an Internet connection.

1. Log into your system as a user with administrative privileges.
2. Click **Start**→ **Help and Support**.
3. Click **Hardware**.
4. In the **Hardware** frame, click the device with which you are having a problem and then press <Enter>.
5. In the search results, select the option that best describes the problem and follow the remaining troubleshooting steps.

Microsoft Windows XP:

1. Click **Start**→ **Help and Support**.
2. Type `hardware troubleshooter` in the search field and press <Enter> to start the search.
3. In the **Fix a Problem** section, click **Hardware Troubleshooter**.
4. In the **Hardware Troubleshooter** list, select the option that best describes the problem and click **Next** to follow the remaining troubleshooting steps.

Microsoft Windows Vista:

1. Click the Windows Vista start button , and click **Help and Support**.
2. Type `hardware troubleshooter` in the search field and press <Enter> to start the search.
3. In the search results, select the option that best describes the problem and follow the remaining troubleshooting steps.

Dell Diagnostics

 **WARNING:** Before working inside your computer, read the safety information that shipped with your computer. For additional safety best practices information, see the Regulatory Compliance Homepage at www.dell.com/regulatory_compliance.

When to Use the Dell Diagnostics

If you experience a problem with your computer, perform the checks in [Troubleshooting](#), and then run the Dell Diagnostics before contacting Dell for assistance.

Start the Dell Diagnostics from your hard drive or from the *Drivers and Utilities* media provided with your computer.

 **NOTE:** The *Drivers and Utilities* media is optional and may not ship with your computer. An external optical drive is required to use this media.

 **NOTE:** The Dell Diagnostics only operate on Dell computers.

Starting the Dell Diagnostics From Your Hard Drive

Before running the Dell Diagnostics, enter the BIOS Setup Utility to review your computer's configuration information, and ensure that the device you want to test is displayed in the BIOS Setup Utility and is active.

 **NOTE:** If your computer does not display a screen image, contact Dell (see [Contacting Dell](#)).

1. Ensure that the computer is connected to an electrical outlet that is known to be working properly.
2. Turn on (or restart) your computer.
3. When the DELL logo appears, press <F12> immediately.

 **NOTE:** Keyboard failure may result when a key is held down for extended periods of time. To avoid possible keyboard failure, press and release <F12> in even intervals to open the Boot Device Menu.

 **NOTE:** If you wait too long and the operating system logo appears, allow the operating system to boot, then shut off your computer and try again.

4. Use the up- and down-arrow keys to select **PSA+** from the boot menu and then press <Enter>.

The computer runs the PSA (Pre-boot System Assessment), a series of initial tests of your system board, keyboard, display, memory, hard drive, etc.

 **NOTE:** The Pre-boot System Assessment may take several minutes to complete.

1. Answer any questions that appear. If prompted, opt to run all memory tests.
1. If failures are detected, write down the error code(s) and see [Contacting Dell](#).
1. If the Pre-boot System Assessment completes successfully, the following message appears: "Booting Dell Diagnostic Utility Partition. Press any key to continue."

 **NOTE:** If you see a message stating that no diagnostics utility partition has been found, run the Dell Diagnostics from your *Drivers and Utilities* media (see [Starting the Dell Diagnostics From the Drivers and Utilities Media](#)).

5. Press any key to start the Dell Diagnostics from the diagnostics utility partition on your hard drive.
6. Press <Tab> to select **Test System** and then press <Enter>.

 **NOTE:** It is recommended that you select **Test System** to run a complete test on your computer. Selecting **Test Memory** initiates the extended memory test, which can take up to thirty minutes or more to complete. When the test completes, record the test results and then press any key to return to the previous menu.

7. At the **Dell Diagnostics Main Menu**, left-click with the mouse, or press <Tab> and then <Enter>, to select the test you want to run (see [Dell Diagnostics Main Menu](#)).

 **NOTE:** Write down any error codes and problem descriptions exactly as they appear and follow the instructions on the screen.

8. After all tests have completed, close the test window to return to the **Dell Diagnostics Main Menu**.
9. Close the main menu window to exit the Dell Diagnostics and restart the computer.

Starting the Dell Diagnostics From the Drivers and Utilities Media

Before running the Dell Diagnostics, enter the BIOS Setup Utility (see [Entering the BIOS Setup Utility](#)) to review your computer's configuration information, and ensure that the device you want to test is displayed in the BIOS Setup Utility and is active.

1. Connect an external optical drive to the computer.
2. Insert the *Drivers and Utilities* media into the optical drive.
3. Restart your computer.
4. When the DELL logo appears, press <F12> immediately.

 **NOTE:** Keyboard failure may result when a key is held down for extended periods of time. To avoid possible keyboard failure, press and release <F12> in even intervals to open the Boot Device Menu.

 **NOTE:** If you wait too long and the operating system logo appears, continue to wait until you see the Microsoft Windows desktop, then shut down your computer and try again.

5. When the boot device list appears, use the up- or down- arrow keys to highlight **CD/DVD/CD-RW Drive** then press <Enter>.

 **NOTE:** Using the one-time boot menu changes the boot sequence for the current boot only. Upon restart, the computer boots according to the boot sequence specified in the BIOS Setup Utility.

6. Press any key to confirm that you want to start from the CD/DVD.
7. Type 1 to **Run the 32 Bit Dell Diagnostics**.
8. At the **Dell Diagnostics Main Menu**, type 1 to select **Dell 32-bit Diagnostics for Resource CD (graphical user interface)**.
9. Press <Tab> to select **Test System** and then press <Enter>.

 **NOTE:** It is recommended that you select **Test System** to run a complete test on your computer. Selecting **Test Memory** initiates the extended memory test, which can take up to thirty minutes or more to complete. When the test completes, record the test results and then press any key to return to the previous menu.

10. At the **Dell Diagnostics Main Menu**, left-click with the mouse, or press <Tab> and then <Enter>, to select the test you want to run (see [Dell Diagnostics Main Menu](#)).

 **NOTE:** Write down any error codes and problem descriptions exactly as they appear and follow the instructions on the screen.

11. After all tests have completed, close the test window to return to the **Dell Diagnostics Main Menu**.
12. Close the main menu window to exit the Dell Diagnostics and restart the computer.
13. Remove the *Drivers and Utilities* media from the optical drive.

Dell Diagnostics Main Menu

After the Dell Diagnostics loads the following menu appears:

Option	Function
Test Memory	Run the stand-alone memory test
Test System	Run system diagnostics
Exit	Exit the diagnostics

Press <Tab> to select the test you want to run and then press <Enter>.

 **NOTE:** It is recommended that you select **Test System** to run a complete test on your computer. Selecting **Test Memory** initiates the extended memory test, which can take up to thirty minutes or more to complete. When the test completes, record the test results and then press any key to return to this menu.

After **Test System** is selected, the following menu appears:

Option	Function
Express Test	Performs a quick test of devices in the system. This typically can take 10 to 20 minutes. NOTE: The Express Test requires no interaction on your part. Run Express Test first to increase the possibility of tracing a problem quickly.
Extended Test	Performs a thorough check of devices in the system. This typically can take an hour or more. NOTE: The Extended Test periodically requires your input to answer specific questions.
Custom Test	Use to test a specific device or customize the tests to be run.
Symptom Tree	This option allows you to select tests based on a symptom of the problem you are having. This option lists the most common symptoms.

 **NOTE:** It is recommended that you select **Extended Test** to perform a more thorough check of devices in the computer.

For any problem encountered during a test, a message appears with an error code and a description of the problem. Write down the error code and problem description exactly as it appears and follow the instructions on the screen. If you cannot resolve the problem, contact Dell (see [Contacting Dell](#)).

 **NOTE:** When contacting Dell support, have your Service Tag ready. The Service Tag for your computer is located at the top of each test screen.

The following tabs provide additional information for tests run from the Custom Test or Symptom Tree option:

Tab	Function
Results	Displays the results of the test and any error conditions encountered.
Errors	Displays error conditions encountered, error codes, and the problem description.
Help	Describes the test and any requirements for running the test.
Configuration	<p>Displays the hardware configuration for the selected device.</p> <p>The Dell Diagnostics obtains configuration information for all devices from the BIOS, memory, and various internal tests, and displays the information in the device list in the left pane of the screen.</p> <p>NOTE: The device list may not display the names of all components installed on your computer or all devices attached to your computer.</p>
Parameters	Allows you to customize the test, if applicable, by changing the test settings.



Solving Problems

Follow these tips when troubleshooting your computer:

- 1 If you added or removed a part before the problem started, review the installation procedures and ensure that the part is correctly installed.
- 1 If a peripheral device does not work, ensure that the device is properly connected.
- 1 If an error message appears on the screen, write down the exact message. This message may help support personnel diagnose and fix the problem(s).
- 1 If an error message occurs in a program, see the program's documentation.

 **NOTE:** The procedures in this document were written for the Windows default view, so they may not apply if you set your Dell™ computer to the Windows Classic view.

Battery Problems

-  **WARNING:** There is a danger of a new battery exploding if it is incorrectly installed. Replace the battery only with the same or equivalent type recommended by the manufacturer. Discard used batteries according to the manufacturer's instructions.
-  **WARNING:** Before working inside your computer, read the safety information that shipped with your computer. For additional safety best practices information, see the Regulatory Compliance Homepage at www.dell.com/regulatory_compliance.

Replace the battery — If you have to repeatedly reset time and date information after turning on the computer, or if an incorrect time or date displays during start-up, replace the battery (see [Coin-Cell Battery](#)). If the battery still does not work properly, contact Dell (see [Contacting Dell](#)).

Drive Problems

-  **WARNING:** Before working inside your computer, read the safety information that shipped with your computer. For additional safety best practices information, see the Regulatory Compliance Homepage at www.dell.com/regulatory_compliance.

Ensure that Microsoft® Windows® Recognizes the drive —

Windows XP Embedded:

- 1 Right-click the **Start button** and then click **Explore**.

Windows XP:

- 1 Click **Start** and click **My Computer**.

Windows Vista®:

- 1 Click the Windows Vista Start button  and click **Computer**.

If the drive is not listed, perform a full scan with your antivirus software to check for and remove viruses. Viruses can sometimes prevent Windows from recognizing the drive.

Check cable connections — Check the HDD cable connections (see [Hard Drive Assembly \(Optional\)](#)), and NVRAM module (see [NVRAM Module](#)) to ensure that they are seated properly.

Clean the drive or disc — use commercially available disc cleaning materials to ensure the disc and optical drive are clean.

Run the Hardware Troubleshooter — See [Hardware Troubleshooter](#).

Run the Dell Diagnostics — See [Dell Diagnostics](#).

Optical drive problems (optional, external)

 **NOTE:** High-speed optical drive vibration is normal and may cause noise, which does not indicate a defect in the drive or the media.

 **NOTE:** Because of different regions worldwide and different disc formats, not all DVD titles work in all DVD drives.

Adjust the Windows volume control —

1. Click the speaker icon in the lower-right corner of your screen.
1. Ensure that the volume is turned up by clicking the slider and dragging it up.
1. Ensure that the sound is not muted by clicking any boxes that are checked.

Check the speakers — See [Sound and Speaker Problems](#).

Problems writing to an optical drive

Close other programs — The optical drive must receive a steady stream of data during the writing process. If the stream is interrupted, an error occurs. Try closing all programs before you write to the optical drive.

Turn off standby mode in Windows before writing to a disc — Search for the keyword *standby* in Windows Help and Support for information on power management modes.

Hard drive problems

Run Check Disk —

Windows XP Extended:

1. Log in to the system as a user with administrative privileges.
2. Right-click the **Start button**, and click **Explore**.
3. In the **Folders** list, right-click the disk you want to check (**OS(C:)**, or **OS(D:)**, or etc.) and click **Properties**.
4. Click **Tools**→ **Check Now**.
5. Click **Scan for and attempt recovery of bad sectors** and click **Start**.
6. If a disk problem is found, follow the screen instructions to fix the problem.

Windows XP:

1. Click **Start** and click **My Computer**.
2. Right-click **Local Disk C:**.
3. Click **Properties**→ **Tools**→ **Check Now**.
4. Click **Scan for and attempt recovery of bad sectors** and then click **Start**.

5. If a disk problem is found, follow the screen instructions to fix the problem.

Windows Vista:

1. Click **Start**  and click **Computer**.
2. Right-click **Local Disk C:**.
3. Click **Properties**→ **Tools**→ **Check Now**.

The **User Account Control** window may appear. If you are an administrator on the computer, click **Continue**; otherwise, contact your administrator to continue the desired action.

4. Follow the instructions on the screen.

E-Mail and Internet Problems

 **WARNING:** Before working inside your computer, read the safety information that shipped with your computer. For additional safety best practices information, see the Regulatory Compliance Homepage at www.dell.com/regulatory_compliance.

Check the Microsoft Outlook® Express security settings — If you cannot open your e-mail attachments:

1. In Outlook Express, click **Tools**→ **Options**→ **Security**.
2. Click **Do not allow attachments** to remove the checkmark, as needed.

Ensure that you are connected to the Internet — Ensure that you have subscribed to an Internet provider. With the Outlook Express e-mail program open, click **File**. If **Work Offline** has a checkmark next to it, click the checkmark to remove it and connect to the Internet. For help, contact your Internet service provider.

Error Messages

 **WARNING:** Before working inside your computer, read the safety information that shipped with your computer. For additional safety best practices information, see the Regulatory Compliance Homepage at www.dell.com/regulatory_compliance.

If the error message is not listed, see the documentation for the operating system or the program that was running when the message appeared.

A filename cannot contain any of the following characters: \ / : * ? " < > | — Do not use these characters in filenames.

A required .DLL file was not found — The program that you are trying to open is missing an essential file. To remove and then reinstall the program:

Windows XP and XP Embedded:

1. Attempt to remove the program with the program's uninstall utility, if provided. If that is unsuccessful, continue with the following steps.
2. Log in to the system as a user with administrative privileges.
3. Attempt to remove the program with the program's uninstall utility. If that is unsuccessful, continue with the following steps.
4. Click **Start**→ **Control Panel**→ **Add or Remove Programs**.
5. Click the program you want to remove.
6. Click **Remove** or **Change/Remove**.
7. See the program documentation for installation instructions.

Windows Vista:

1. Click **Start**  → **Control Panel**→ **Programs**→ **Programs and Features**.
2. Select the program you want to remove.

3. Click **Uninstall**.
4. See the program documentation for installation instructions.

drive letter :\< is not accessible. The device is not ready — The drive cannot read the disk. Insert a disk into the drive and try again.

Insert bootable media — Insert a bootable floppy disk, CD, or DVD.

Non-system disk error — Remove the floppy disk from the floppy drive and restart your computer.

Not enough memory or resources. Close some programs and try again — Close all windows and open the program that you want to use. In some cases, you may have to restart your computer to restore computer resources. If so, run the program that you want to use first.

Operating system not found — Contact Dell (see [Contacting Dell](#)).

Keyboard Problems

 **WARNING:** Before working inside your computer, read the safety information that shipped with your computer. For additional safety best practices information, see the Regulatory Compliance Homepage at www.dell.com/regulatory_compliance.

Check the keyboard cable —

- 1 Ensure that the keyboard cable is firmly connected to the computer.
- 1 Shut down the computer, reconnect the keyboard cable, and then restart the computer.
- 1 Ensure that the cable is not damaged or frayed and check cable connectors for bent or broken pins. Straighten any bent pins.
- 1 Remove any keyboard extension cables and connect the keyboard directly to the computer.

Test the keyboard — Connect a properly working keyboard to the computer, then try using the keyboard.

Run the Hardware Troubleshooter — See [Hardware Troubleshooter](#).

Lockups and Software Problems

 **WARNING:** Before working inside your computer, read the safety information that shipped with your computer. For additional safety best practices information, see the Regulatory Compliance Homepage at www.dell.com/regulatory_compliance.

The computer does not start up

Check the diagnostic lights — See [Diagnostic Lights](#).

Ensure that the power cable is firmly connected to the computer and to the electrical outlet

The computer stops responding

 **CAUTION:** You may lose data if you are unable to perform an operating system shutdown.

Turn the computer off — If you are unable to get a response by pressing a key on your keyboard or moving your mouse, press and hold the power button for at least 8 to 10 seconds (until the computer turns off), and then restart your computer.

A program stops responding

End the program —

1. Press <Ctrl><Shift><Esc> simultaneously to access the Task Manager.
2. Click the **Applications** tab.
3. Click to select the program that is no longer responding.
4. Click **End Task**.

A program crashes repeatedly

 **NOTE:** Most software includes installation instructions in its documentation or on a floppy disk, CD, or DVD.

Check the software documentation — If necessary, uninstall and then reinstall the program.

A program is designed for an earlier Windows operating system

Run the Program Compatibility Wizard —

Windows XP Embedded:

A Program Compatibility Wizard is not provided within Windows XP Embedded. It is available through an Internet connection to the Microsoft website. To use this feature:

1. Click **Start**→ **Control Panel**→ **Help and Support**.
2. Under the **Pick a task** heading, click **Find compatible hardware and software for Windows XP**.
3. Follow the instructions on the screen.

Windows XP:

The Program Compatibility Wizard configures a program so that it runs in an environment similar to non-XP operating system environments.

1. Click **Start**→ **All Programs**→ **Accessories**→ **Program Compatibility Wizard**→ **Next**.
2. Follow the instructions on the screen.

Windows Vista:

The Program Compatibility Wizard configures a program so that it runs in an environment similar to non-Windows Vista operating system environments.

1. Click **Start**  → **Control Panel**→ **Programs**→ **Use an older program with this version of Windows**.
2. In the welcome screen, click **Next**.
3. Follow the instructions on the screen.

A solid blue screen appears

Turn the computer off — If you are unable to get a response by pressing a key on your keyboard or moving your mouse, press and hold the power button for at least 8 to 10 seconds (until the computer turns off), and then restart your computer.

Other software problems

Check the software documentation or contact the software manufacturer for troubleshooting information —

- 1 Ensure that the program is compatible with the operating system installed on your computer.
- 1 Ensure that your computer meets the minimum hardware requirements needed to run the software. See the software documentation for information.
- 1 Ensure that the program is installed and configured properly.
- 1 Verify that the device drivers do not conflict with the program.
- 1 If necessary, uninstall and then reinstall the program.

Back up your files immediately

Use a virus-scanning program to check the hard drive, floppy disks, CDs, or DVDs

Save and close any open files or programs and shut down your computer through the Start menu

Memory Problems

 **WARNING:** Before working inside your computer, read the safety information that shipped with your computer. For additional safety best practices information, see the Regulatory Compliance Homepage at www.dell.com/regulatory_compliance.

If you receive an insufficient memory message —

- 1 Save and close any open files and exit any open programs you are not using to see if that resolves the problem.
- 1 See the software documentation for minimum memory requirements. If necessary, install additional memory (see [Memory](#)).
- 1 Reseat the memory modules (see [Memory](#)) to ensure that your computer is successfully communicating with the memory.
- 1 Run the Dell Diagnostics (see [Dell Diagnostics](#)).

If you experience other memory problems —

- 1 Reseat the memory modules (see [Memory](#)) to ensure that your computer is successfully communicating with the memory.
- 1 Ensure that you are following the memory installation guidelines (see [Memory](#)).
- 1 Ensure that the memory you are using is supported by your computer. For more information about the type of memory supported by your computer, see [Memory](#).
- 1 Run the Dell Diagnostics (see [Dell Diagnostics](#)).

Mouse Problems

 **WARNING:** Before working inside your computer, read the safety information that shipped with your computer. For additional safety best practices information, see the Regulatory Compliance Homepage at www.dell.com/regulatory_compliance.

Check the mouse cable —

- 1 Ensure that the cable is not damaged or frayed and check cable connectors for bent or broken pins. Straighten any bent pins.
- 1 Remove any mouse extension cables, and connect the mouse directly to the computer.
- 1 Verify that the mouse cable connector is seated properly.

Restart the computer —

1. Simultaneously press <Ctrl><Esc> to display the **Start** menu.
2. Press <u>, press the up- and down-arrow keys to highlight **Shut down** or **Turn Off**, and then press <Enter>.
3. After the computer turns off, reconnect the mouse cable.
4. Turn on the computer.

Test the mouse — Connect a properly working mouse to the computer, then try using the mouse.

Check the mouse settings —

Windows XP and Windows XP Embedded:

1. Click **Start**→ **Control Panel**.
2. If the **Control Panel** window appears in Category View (**Pick a category**), switch to Classic View (icon view).
3. Click **Mouse**.
4. Adjust the settings as needed.

Windows Vista:

1. Click **Start**  → **Control Panel**→ **Hardware and Sound**→ **Mouse**.
2. Adjust the settings as needed.

Reinstall the mouse driver — See [Reinstalling Drivers and Utilities](#).

Run the Hardware Troubleshooter — See [Hardware Troubleshooter](#).

Network Problems

 **WARNING:** Before working inside your computer, read the safety information that shipped with your computer. For additional safety best practices information, see the Regulatory Compliance Homepage at www.dell.com/regulatory_compliance.

Check the network activity indicator on the front of the computer — If the activity indicator is off, the network is not active. Check the network cable connection on the back of the computer to ensure the connector is seated properly.

Check the network cable connector — Ensure that the network cable is firmly inserted into the network connector on the back of the computer and the network jack.

Check the network lights on the back of the computer — If the Activity LED flashes yellow with network activity, and the Link LED is:

- 1 Green – indicates a 10 Mbps connection
- 1 Orange – indicates a 100 Mbps connection
- 1 Yellow – indicates a 1000 Mbps connection

If either the Activity LED or Link LED is off, no network communication is occurring. Replace the network cable. Restart the computer and log on to the network again.

Check your network settings — Contact your network administrator or the person who set up your network to verify that your network settings are correct and that the network is functioning.

Run the Hardware Troubleshooter — See [Hardware Troubleshooter](#).

Power Problems

 **WARNING:** Before working inside your computer, read the safety information that shipped with your computer. For additional safety best practices information, see the Regulatory Compliance Homepage at www.dell.com/regulatory_compliance.

If the power light is blue and the computer is not responding — See [Diagnostic Lights](#).

If the power light is blinking blue — The computer is in standby mode. Press a key on the keyboard, move the mouse, or press the power button to resume normal operation.

If the power light is off — The computer is either turned off or is not receiving power.

- 1 Reseat the power cable in the power connector on the back of the computer and the electrical outlet.
- 1 Bypass power strips, power extension cables, and other power protection devices to verify that the computer turns on properly.
- 1 Ensure that any power strips being used are plugged into an electrical outlet and are turned on.
- 1 Ensure that the electrical outlet is working by testing it with another device, such as a lamp.
- 1 Ensure that the 12V power cable and front panel cable are securely connected to the system board (see [System Board Connectors](#)).

If the power light is steady amber — A device may be malfunctioning or incorrectly installed.

- 1 Remove and then reinstall all memory modules (see [Memory](#)).
- 1 Remove and then reinstall the NVRAM module, if installed (see [NVRAM Module](#)).
- 1 Remove and then reinstall the wireless card, if installed (see [Wireless Card](#)).

Eliminate interference — Some possible causes of interference are:

- 1 Power, keyboard, and mouse extension cables
- 1 Too many devices connected to the same power strip
- 1 Multiple power strips connected to the same electrical outlet

Printer Problems



WARNING: Before working inside your computer, read the safety information that shipped with your computer. For additional safety best practices information, see the [Regulatory Compliance Homepage](http://www.dell.com/regulatory_compliance) at www.dell.com/regulatory_compliance.



NOTE: If you need technical assistance for your printer, contact the printer's manufacturer.

Check the printer documentation — See the printer documentation for setup and troubleshooting information.

Ensure that the printer is turned on

Check the printer cable connections —

- 1 See the printer documentation for cable connection information.
- 1 Ensure that the printer cables are securely connected to the printer and the computer.

Test the electrical outlet — Ensure that the electrical outlet is working by testing it with another device, such as a lamp.

Verify that the printer is recognized by Windows —

Windows XP and Windows XP Embedded:

1. Click **Start**→ **Control Panel**
2. If the **Control Panel** window appears in Category View (**Pick a category**), switch to Classic View (icon view).
3. Double-click **Printers and Faxes**.
4. If the printer is listed, right-click the printer icon.
5. Click **Properties**→ **Ports**. For a USB printer connected directly to your computer, ensure that the **Print to the following port(s)**: setting is **USB**.

Windows Vista:

1. Click **Start**  → **Control Panel**→ **Hardware and Sound**→ **Printer**.
2. If the printer is listed, right-click the printer icon.
3. Click **Properties**→ **Ports**.
4. Adjust the settings, as needed.

Reinstall the printer driver — See the printer documentation for information on reinstalling the printer driver.

Scanner Problems

 **WARNING:** Before working inside your computer, read the safety information that shipped with your computer. For additional safety best practices information, see the [Regulatory Compliance Homepage](http://www.dell.com/regulatory_compliance) at www.dell.com/regulatory_compliance.

 **NOTE:** If you need technical assistance for your scanner, contact the scanner's manufacturer.

Check the scanner documentation — See the scanner documentation for setup and troubleshooting information.

Unlock the scanner — Ensure that your scanner is unlocked (if the scanner has a locking tab or button).

Restart the computer and try the scanner again

Check the cable connections —

- 1 See the scanner documentation for information on cable connections.
- 1 Ensure that the scanner cables are securely connected to the scanner and the computer.

Verify that the scanner is recognized by Microsoft Windows —

Windows XP Embedded:

1. Click **Start**→ **Control Panel**.
2. If the **Control Panel** window appears in Category View (**Pick a category**), switch to Classic View (icon view).
3. Double-click **System**→ **Hardware**→ **Device Manger**.
4. If your scanner is listed in any category, Windows recognizes the scanner.

Windows XP:

1. Click **Start**→ **Control Panel**→ **Scanners and Cameras**.
2. If your scanner is listed, Windows recognizes the scanner.

Windows Vista:

1. Click **Start**  → **Control Panel**→ **Hardware and Sound**→ **Scanners and Cameras**.
2. If the scanner is listed, Windows recognizes the scanner.

Reinstall the scanner driver — See the scanner documentation for instructions.

Sound and Speaker Problems

 **WARNING:** Before working inside your computer, read the safety information that shipped with your computer. For additional safety best practices information, see the [Regulatory Compliance Homepage](http://www.dell.com/regulatory_compliance) at www.dell.com/regulatory_compliance.

No sound from speakers

 **NOTE:** The volume control in MP3 and other media players may override the Windows volume setting. Always check to ensure that the volume on the media player(s) has not been turned down or off.

Check the speaker cable connections — Ensure that the speakers are connected as shown on the setup diagram supplied with the speakers.

Ensure that the speakers are turned on — See the setup diagram supplied with the speakers. If your speakers have volume controls, adjust the volume, bass, or treble to eliminate distortion.

Adjust the Windows volume control — Click or double-click the speaker icon in the lower-right corner of your screen. Ensure that the volume is turned up and that the sound is not muted.

Disconnect headphones from the headphone connector — Sound from the speakers is automatically disabled when headphones are connected to the computer's front-panel headphone connector.

Test the electrical outlet — Ensure that the electrical outlet is working by testing it with another device, such as a lamp.

Eliminate possible interference — Turn off nearby fans, fluorescent lights, or halogen lamps to check for interference.

Run the speaker diagnostics

Reinstall the sound driver — See [Drivers](#).

Run the Hardware Troubleshooter — See [Hardware Troubleshooter](#).

No sound from headphones

Check the headphone cable connection — Ensure that the headphone cable is securely inserted into the headphone connector.

Adjust the Windows volume control — Click or double-click the speaker icon in the lower-right corner of your screen. Ensure that the volume is turned up and that the sound is not muted.

Mouse Problems

Check the mouse settings —

1. Click **Start**→ **Control Panel**→ **Printers and Other Hardware**→ **Mouse**.
2. Try adjusting the settings.

Check the mouse cable — Shut down the computer. Disconnect the mouse cable, check it for damage, and firmly reconnect the cable.

If you are using a mouse extension cable, disconnect it and connect the mouse directly to the computer.

Check the BIOS Setup Utility program settings — Verify that the BIOS Setup Utility lists the correct device for the pointing device option. (The computer automatically recognizes a USB mouse without making any setting adjustments.) See the [BIOS Setup Utility Screens](#).

Test the mouse controller — To test the mouse controller (which affects pointer movement) and the operation of the mouse buttons, run the Mouse test in the **Pointing Devices** test group in the Dell Diagnostics (see [Dell Diagnostics](#)).

Reinstall the mouse driver — See [Reinstalling Drivers and Utilities](#).

Video and Monitor Problems

 **WARNING:** Before working inside your computer, read the safety information that shipped with your computer. For additional safety best practices information, see the Regulatory Compliance Homepage at www.dell.com/regulatory_compliance.

The screen is blank

 **NOTE:** For troubleshooting procedures, see the monitor's documentation.

The screen is difficult to read

Check the monitor cable connection —

1. Ensure that the monitor cable connector is properly attached to the video connector.
1. Remove any video extension cables and connect the monitor directly to the computer.
1. Swap the computer and monitor power cables to determine if the monitor's power cable is defective.
1. Check the connectors for bent or broken pins (it is normal for monitor cable connectors to have missing pins).

Check the monitor power light —

1. If the power light is lit or blinking, the monitor has power.
1. If the power light is off, firmly press the button to ensure that the monitor is turned on.
1. If the power light is blinking, press a key on the keyboard or move the mouse to resume normal operation.

Test the electrical outlet — Ensure that the electrical outlet is working by testing it with another device, such as a lamp.

Check the diagnostic lights — See [Diagnostic Lights](#).

Check the monitor settings — See the monitor documentation for instructions on adjusting the contrast and brightness, demagnetizing (degaussing) the monitor, and running the monitor self-test.

Move the monitor away from external power sources — Fans, fluorescent lights, halogen lamps, and other electrical devices can cause the screen image to appear *shaky*. Turn off nearby devices to check for interference.

Rotate the monitor to eliminate sunlight glare and possible interference

Adjust the Windows display settings —

Windows XP and Windows XP Embedded:

1. Right-click anywhere on the system desktop (not on an icon or within any window), and click **Properties**.
2. Click the **Settings** tab.
3. Try different settings for **Screen resolution** and **Color quality**.

Windows Vista:

1. Click **Start**  → **Control Panel** → **Hardware and Sound** → **Personalization** → **Display Settings**.
2. Adjust **Resolution** and **Colors settings**, as needed.

Dell Technical Update Service

The Dell Technical Update service provides proactive e-mail notification of software and hardware updates for your computer. The service is free and can be customized for content, format, and how frequently you receive notifications.

To enroll for the Dell Technical Update service, go to support.dell.com/technicalupdate.

[Back to Contents Page](#)

Selective USB

Dell™ OptiPlex™ FX160/160 Service Manual

- [Overview](#)
- [Enabling Selective USB](#)

Overview

Selective USB allows administrators to restrict two USB ports to support only a keyboard and a mouse and disable all other USB ports.

When using a selective USB port, you must connect the keyboard and mouse to the specific USB ports before booting the computer. A keyboard (without a USB hub) is required for the system to boot. When Selective USB is enabled and either the keyboard or mouse is removed the Selective USB feature automatically disables the designated ports.

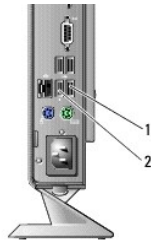

1	Port 1 – mouse selective USB port	2	Port 0 – keyboard selective USB port
---	-----------------------------------	---	--------------------------------------

Enabling Selective USB

1. Turn off the computer.
2. Connect authorized USB devices in the selective USB ports.
3. Turn on the computer and press <F2> to enter the BIOS Setup Utility (see [Entering the BIOS Setup Utility](#)).
4. Use the **Onboard Devices** screen to enable **Selective USB**.

When enabled, the two selective USB ports will function with authorized USB devices only. All other USB ports will be disabled.

 **NOTE:** If a mouse is not attached to USB port 1, the port is disabled.

5. Save the settings and reboot the computer.

During POST, the BIOS will check whether authorized USB devices are connected to the selective USB ports. If the devices are connected, the computer boots as normal. If devices are not connected, the computer prompts you to connect the authorized USB devices and reboot the system.

 **NOTE:** If you disconnect a device from the selective USB port, the port becomes disabled. To re-enable the port, connect the device, power off, and reboot the system.

Wireless Card

Dell™ OptiPlex™ FX160/160 Service Manual

- [Removing the Wireless Card](#)
- [Replacing the Wireless Card](#)

Removing the Wireless Card

1. Perform the procedure in [Before Working on Your Computer](#).
2. Remove the hard drive bracket assembly, if installed ([Removing the Hard Drive Bracket Assembly](#)).
3. Pull back the metal tab until the wireless card pops up at a 45-degree angle.

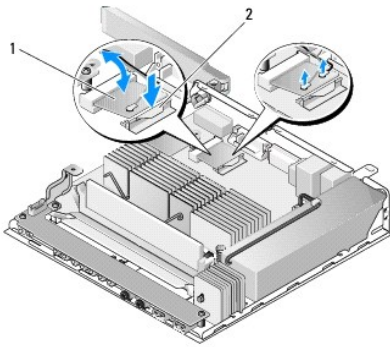

1	wireless card	2	metal tab
---	---------------	---	-----------

4. Pull the wireless card out of the system board connector.
5. Disconnect the antenna cables from the wireless card.

Replacing the Wireless Card

1. Connect the white antenna cable to the connector marked with the white triangle, and connect the black antenna cable to the connector labeled with a black triangle.
2. Insert the wireless card into the WLAN connector on the system board at a 45-degree angle.
3. Press the card downward until the metal clip snaps into place.

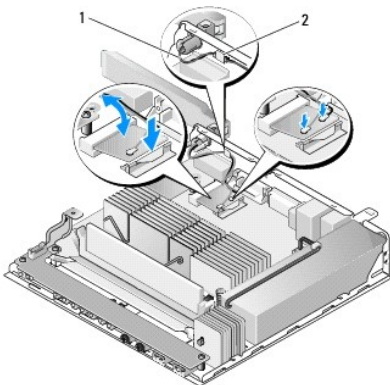

1	antenna wires	2	tab and metal mesh sleeve
---	---------------	---	---------------------------

-
4. Route the antenna cable to ensure that the metal mesh sleeve on the cable is secured by the tab on the back panel.
 5. Replace the hard drive bracket assembly if it was removed (see [Replacing the Hard Drive Bracket Assembly](#)).
 6. Perform the procedure in [After Working on Your Computer](#).
-

[Back to Contents Page](#)